



# CHCNAV i83 GNSS User Guide



Make your work more efficient

# Table of Content

<b>Table of Content.....</b>	<b>2</b>
<b>Preface .....</b>	<b>5</b>
Copyright.....	5
Safety Warnings.....	5
FCC Interference Statement .....	5
CE Interference Statement .....	6
<b>1 Introduction.....</b>	<b>7</b>
1.1 Safety Information.....	7
1.1.1 Warnings and Cautions.....	7
1.2 Regulations and Safety .....	7
1.2.1 Use and Care.....	8
1.3 Technical Support.....	8
1.4 Disclaimer .....	8
1.5 Your Comments .....	8
<b>2 Getting Started with i83 .....</b>	<b>9</b>
2.1 About the Receiver .....	9
2.2 Parts of the Receiver .....	9
2.2.1 Front Panel .....	9
2.2.2 Lower Housing.....	11
2.2.3 Receiver Ports.....	11
2.3 Batteries and Power .....	12
2.3.1 Batteries .....	12
2.3.2 The Internal Battery.....	12
2.3.3 Battery Safe .....	13
2.3.4 External Power Supply .....	14
2.4 Inserting SIM Card .....	14
2.5 Product Basic Supply Accessories.....	15
2.5.1 Base Kit Basic Supply .....	15
2.5.2 Rover Kit Basic Supply .....	16
2.6 Connecting to an Office Computer.....	17
2.7 Connecting to a Controller .....	18
2.7.1 Connecting via Wi-Fi with LandStar 7 Software .....	18
2.7.2 Connecting via Bluetooth with LandStar 7 Software.....	20
2.8 Downloading Logged Data.....	22
2.8.1 FTP Download.....	22
2.8.2 Web Server Download.....	23

2.8.3	USB Download .....	24
<b>3</b>	<b>Front Panel Operation .....</b>	<b>26</b>
3.1	Main Operation Menus .....	26
3.2	Configure the Working Mode.....	28
<b>4</b>	<b>Equipment Setup and Operation.....</b>	<b>33</b>
4.1	Post-processing Base Station Setup .....	33
4.2	Real-Time Base Station Setup.....	34
4.2.1	Internal Cellular or UHF .....	34
4.2.2	External UHF .....	35
4.3	Real-Time Rover Station Setup.....	37
4.4	Working with the Tilt Compensation .....	38
4.4.1	Operation Steps.....	38
4.4.2	Notes of using tilt measurement.....	41
<b>5</b>	<b>Configuring Through a Web Browser.....</b>	<b>42</b>
5.1	Status Menu .....	43
5.1.1	Position Submenu.....	44
5.1.2	Activity Submenu.....	44
5.1.3	Google Map Submenu .....	45
5.2	Satellites Menu.....	46
5.2.1	Tracking Table Submenu .....	46
5.2.2	Tracking Info. Table Submenu .....	47
5.2.3	Tracking Skyplot Submenu.....	47
5.2.4	Satellite Activation Submenu .....	48
5.3	Receiver Configuration Menu .....	48
5.3.1	Description .....	49
5.3.2	Antenna Configuration Submenu.....	49
5.3.3	Reference Station Settings Submenu .....	49
5.3.4	Receiver Reset Submenu .....	52
5.3.5	Languages Submenu.....	52
5.3.6	User Management Submenu.....	53
5.3.7	HCPPP Settings .....	53
5.4	Data Recording Menu.....	53
5.4.1	Log Settings Submenu .....	54
5.4.2	FTP Push Settings Submenu .....	57
5.4.3	FTP Push Log Submenu.....	58
5.4.4	Data Download Submenu.....	58
5.5	IO Settings Menu .....	60
5.5.1	IO Settings Submenu .....	60
5.6	Network Setting Menu .....	67
5.6.1	Description Submenu .....	67
5.6.2	Mobile Network Setting Submenu .....	68

5.6.3	Email Alarm Submenu .....	68
5.6.4	HTTP Submenu .....	69
5.6.5	HTTPS Submenu .....	70
5.6.6	FTP Service Submenu .....	70
5.7	Module Setting Menu.....	70
5.7.1	Description Submenu .....	71
5.7.2	WiFi Submenu .....	71
5.7.3	Bluetooth Settings Submenu.....	71
5.7.4	Radio Settings Submenu.....	72
5.8	Firmware Menu .....	73
5.8.1	Firmware Info Submenu .....	73
5.8.2	Hardware Version Submenu .....	73
5.8.3	Config File Submenu.....	74
5.8.4	System Log Download Submenu .....	74
5.8.5	User Log Submenu.....	74
5.8.6	Firmware Update Submenu.....	75
5.8.7	GNSS Board Upgrade Submenu.....	76
5.8.8	Radio Upgrade Submenu.....	76
5.8.9	Upgrade Online Submenu .....	76
5.8.10	GNSS Registration Submenu.....	77
5.9	Cloud Service Setting Menu .....	77
5.9.1	Cloud Service Setting Submenu.....	77
<b>A Communication Ports Definition .....</b>		<b>78</b>
<b>AI CHC i83 Receiver IO Port (7-pin Lemo Port) Definition .....</b>		<b>78</b>

---

## Preface

## Copyright

### Copyright 2016-2017

CHC | Shanghai Huace Navigation Technology Ltd. All rights reserved. The CHC are trademark of Shanghai Huace Navigation Technology Limited. All other trademarks are the property of their respective owners.

### Trademarks

All product and brand names mentioned in this publication are trademarks of their respective holders.

## Safety Warnings

The Global Positioning System (GPS) is operated by the U.S. Government, which is solely responsible for the accuracy and maintenance of the GPS network. Accuracy can also be affected by poor satellite geometry and obstructions, like buildings and heavy canopy.

## FCC Interference Statement

This equipment has been designed to comply with the limits for a Class B digital device, pursuant to part 15 of the FCC Rules in the Portable Mode. These limits are designed to provide reasonable protection against harmful interference in a residential installation.

Operation is subject to the following two conditions: (1) this device may not cause harmful interference and (2) this device must accept any interference received, including interference that may cause undesired operation.

## CE Interference Statement

Declaration of Conformity: Hereby, Shanghai Huace Navigation Technology Ltd. declares that this i83 is in compliance with the essential requirements and other relevant provisions of Directive 2014/53/EU. A copy of the Declaration of conformity can be found at Shanghai Huace Navigation Technology Ltd.



# 1 Introduction

The i83 GNSS Receiver User Guide describes how to set up and use the CHC® i83 GNSS receiver. In this manual, “the receiver” refers to the i83 GNSS receiver unless otherwise stated. Even if you have used other Global Navigation Satellite Systems (GNSS) products before, CHC recommends that you spend some time reading this manual to learn about the special features of this product. If you are not familiar with GNSS, go to [www.chcnav.com](http://www.chcnav.com) for an interactive look at CHC and GNSS.

## 1.1 Safety Information

### 1.1.1 Warnings and Cautions

An absence of specific alerts does not mean that there are no safety risks involved.

A Warning or Caution information is intended to minimize the risk of personal injury and/or damage to the equipment.



**WARNING** - A Warning alerts you to a potential misused or wrong setting of the equipment.



**CAUTION** - A Caution alerts you to a possible risk of serious injury to your person and/or damage to the equipment.

## 1.2 Regulations and Safety

The receivers contain a built-in wireless modem for signal communication through Bluetooth® wireless technology or through external communication datalink. Regulations regarding the use of the wireless modem vary greatly from country to country. In some countries, the unit can be used without obtaining an end-user license. However, in some countries, the administrative permissions are required. For license information, consult your local dealer. Bluetooth® operates in license-free bands.

Before operating a i83 GNSS receiver, determine if authorization or a license to operate the unit is required in your country. It is the responsibility of the end-user to obtain an operator's permit or license for the receiver for the location or country of use.

### 1.2.1 Use and Care

This receiver is designed to withstand the rough environment that typically occurs in the field. However, the receiver is high-precision electronic equipment and should be treated with reasonable care.



CAUTION - Operating or storing the receiver outside the specified temperature range will cause irreversible damage.

## 1.3 Technical Support

If you have a problem and cannot find the information you need in this manual or CHC website ([www.chcnav.com](http://www.chcnav.com)), contact your local CHC dealer from which you purchased the receiver(s).

If you need to contact CHC technical support, please contact us by email ([support@chcnav.com](mailto:support@chcnav.com)) or Skype (chc\_support).

## 1.4 Disclaimer

Before using the receiver, please make sure that you have read and understood this User Guide, as well as the safety information. CHC holds no responsibility for the wrong operation by users and for the losses incurred by the wrong understanding about this User Guide. However, CHC reserves the rights to update and optimize the contents in this guide regularly. Please contact your local CHC dealer for new information.

## 1.5 Your Comments

Your feedback about this user guide will help us to improve it in future revision. Please email your comments to [support@chcnav.com](mailto:support@chcnav.com).

## 2 Getting Started with i83

### 2.1 About the Receiver

The new CHCNAV i83 GNSS receiver offers integrated IMU-RTK technology to provide a robust and accurate GNSS positioning in any circumstances. Unlike the standard MEMS based GNSS receivers, the i83 GNSS IMU-RTK combines state-of-the-art GNSS RTK engine, calibration-free professional IMU sensor and advanced GNSS tracking capabilities. Survey projects are achieved with high productivity and reliability pushing the boundaries of conventional GNSS RTK survey.

The LCD panel enables user to check satellite-tracking status, internal battery status, Wi-Fi status, working mode, data logging status and basic receiver information. Bluetooth and Wi-Fi technology provides cable-free communication between the receiver and controller.

The receiver can be used as the part of an RTK GNSS system with CHC LansStar7 software. Moreover, user can download the GNSS data that recorded in the internal memory of receiver to a computer.

The receiver can be used as the part of an RTK GNSS system with CHC LandStar 7 software. And you can download the GNSS data that recorded in the internal memory of receiver to a computer.

To configure the receiver for performing a wide variety of functions, you can use the web interface by connecting the receiver with PC or smartphone through Wi-Fi.

### 2.2 Parts of the Receiver

The operating controls are all located on the front panel. SIM card slot is on the backside. Serial ports and connectors are located on the bottom of the unit.

#### 2.2.1 Front Panel

The following figure shows a front view of the receiver.



The front panel contains two indicator LEDs and two buttons.



Name	Description
Correction LED (Yellow/Green)	<ul style="list-style-type: none"> <li>Indicates whether the receiver is transmitting/receiving differential data.</li> <li>As a Base station: successfully transmitting differential data, flash yellow light.</li> <li>As a Rover station: successfully receiving differential data from Base station will flash yellow light when it is single or float, flash green light when it is fixed.</li> </ul>
Satellite LED (Blue)	<ul style="list-style-type: none"> <li>Shows the number of satellites that the receiver has tracked.</li> <li>When the receiver is searching satellites, the blue LED flashes once every 5 seconds.</li> <li>When the receiver has tracked N satellites, the blue LED will flash N times every 5 seconds.</li> </ul>
Fn button (White)	<ul style="list-style-type: none"> <li>Move to next line of the menus or options.</li> <li>Move to next character of the value that you want to make change.</li> <li>Cancel the change you make on a function.</li> </ul>

<p>Power button (White)</p>	<ul style="list-style-type: none"> <li>• Press and hold this button for 3 seconds to turn on or turn off the receiver.</li> </ul>
---------------------------------	---

### 2.2.2 Lower Housing

The lower housing contains one SIM card slot, one TNC radio antenna connector, one communication and power port and one USB type C communication and power port.



### 2.2.3 Receiver Ports



Port	Name	Description
	IO port	<ul style="list-style-type: none"> <li>This port is a 7-pin LEMO connector that supports RS-232 communications and external power input.</li> <li>Users can use HCE600 Type-c Cable supplied with the system to realize RS-232 communications between the receiver and computer or controller. Also, users can use a 7-pin cable to transmit differential data to an external radio.</li> </ul>
	USB port	<ul style="list-style-type: none"> <li>This port is a type-C USB connector that supports USB communications.</li> <li>Users can use USB Cable supplied with the system to download the logged data to a computer.</li> </ul>
	Radio antenna connector	<ul style="list-style-type: none"> <li>Connect a radio antenna to internal radio of the receiver. And this connector is not used if you are using an external radio.</li> </ul>

## 2.3 Batteries and Power

### 2.3.1 Batteries

The receiver has an built-in non-removable Lithium-ion battery.

### 2.3.2 The Internal Battery

The rechargeable Lithium-ion battery is supplied partially charged.

 **WARNING** – Charge and use the rechargeable Lithium-ion battery only in strict accordance with the instructions. Charging or using the battery in unauthorized equipment can cause an explosion or fire and can result in personal injury and/or equipment damage.

To prevent injury or damage:

- Do not charge or use the battery if it appears to be damaged or leaking.
- Charge the Lithium-ion battery only in a CHC product that is specified to charge it. Be sure to follow all instructions that are provided with the battery charger.
- Discontinue charging a battery that gives off extreme heat or a burning odor.
- Use the battery only in CHC equipment that is specified to use it.
- Use the battery only for its intended use and according to the instructions in the product documentation.

### 2.3.3 Battery Safe



**WARNING** – Do not damage the rechargeable Lithium-ion battery. A damaged battery can cause an explosion or fire and can result in personal injury and/or property damage.

To prevent injury or damage:

- Do not use or charge the battery if it appears to be damaged. Signs of damage include, but are not limited to discoloration, warping, and leaking battery fluid.
- Do not expose the battery to fire, high temperature, or direct sunlight.
- Do not immerse the battery in water.
- Do not use or store the battery inside a vehicle under hot weather condition.
- Do not drop or puncture the battery.
- Do not open the battery or short-circuit its contacts.



**WARNING** – Avoid contact with the rechargeable Lithium-ion battery if it appears to be leaking. Battery fluid is corrosive and contact with it can result in personal injury and/or property damage.

To prevent injury or damage:

- If the battery leaks, avoid with the battery fluid.
- If battery fluid gets into your eyes, immediately rinses your eyes with clean water and seek medical attention. Please do not rub your eyes!
- If battery fluid gets onto your skin or clothing, immediately use clean water to wash off the battery fluid.

### 2.3.4 External Power Supply

Two methods are available for providing the external power to the receiver by the GPS to PC Data Cable+ Power Adapter, or GPS to PC Data Cable + external power cable (option purchase) + vehicle battery.

In the office:

The Power Adapter is connecting with AC power of 100-240V, the output port of the Power Adapter connects with the Power Port of the GPS to PC DataCable.

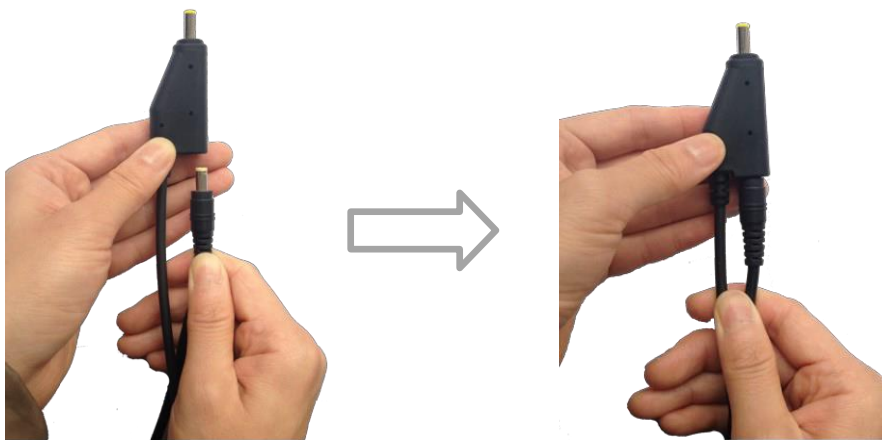

In the field:

The external power cable is connecting with a vehicle battery, the output port of the external power cable connects with the Power Port of the GPS to PC DataCable.



**WARNING** – Use caution when connecting external power cable's clip leads to a vehicle battery. Do not allow any metal object to connect (short) the battery's positive (+) terminal to either the negative (-) terminal or the metal part of the vehicle battery. This could result in high current, arcing, and high temperatures, exposing the user to possible injury.

## 2.4 Inserting SIM Card

- (a) Open the SIM card slot cover.
- (b) Insert the SIM card with the contacts facing upward, as indicated by the SIM card icon next to the SIM card slot.
- (c) Close the cover to prevent water immersion.

(d) To eject the SIM card, slightly push it in to trigger the spring-loaded release mechanism



Insert the SIM card with the contacts facing upward, as indicated by the SIM card icon next to the SIM card slot.

To eject the SIM card, slightly push it in to trigger the spring-loaded release mechanism.

Tip – The SIM card is provided by your cellular network service provider.



## 2.5 Product Basic Supply Accessories

### 2.5.1 Base Kit Basic Supply

Item	Picture
i83 GNSS Receiver	
UHF Bar Antenna (410-470 MHz)	

HCE600 USB Type-C	
H.I. Tape	
Extension pole	
Tribrach with optical plummet	
Auxiliary H.I. Tool	
Transport Hard Case	

**2.5.2 Rover Kit Basic Supply**

Item	Picture
i83 GNSS Receiver	
UHF Bar Antenna (410-470 MHz)	

HCE600 USB Type-C	
Tribrach adaptor	
C300 Pedestal charger	
C300 Power Adapter with Cord	
2M Range Pole w/bag	
Auxiliary H.I. Tool	
Transport Hard Case	

## 2.6 Connecting to an Office Computer

The receiver can be connected to an office computer for serial data transfer or settings via a HCE600 USB Type-C. Before you connect to the office computer, ensure that the receiver is powered on by internal battery or external power.

The following figure shows how to connect to the computer for serial data transfer or settings:

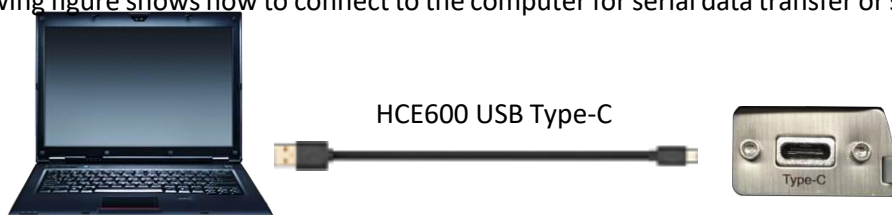

## 2.7 Connecting to a Controller

### 2.7.1 Connecting via Wi-Fi with LandStar 7 Software

Turn on the controller → run LandStar 7 → go to **Config** main menu → tap **Connect**.

In the *Connect* screen, select **CHC** for the *Manufacture* field, **i83** for *Device Type* field, **WIFI** for *Connection Type* field.



Tap the Wireless Lan icon on the right side to select the hot spot → Switch on the WiFi module by the top switch → select the target device in the list.

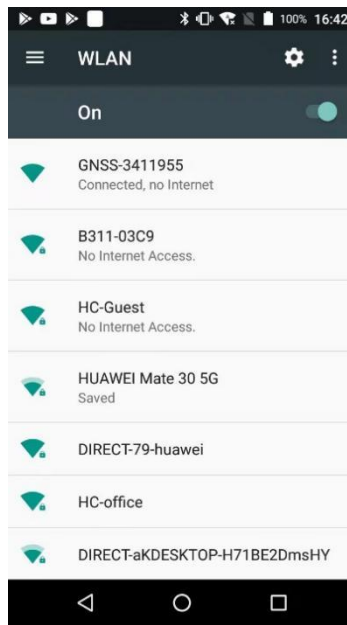

Tap **Connect** to link to the hot spot. If the first-time connection to this hot spot, user may type in the password.

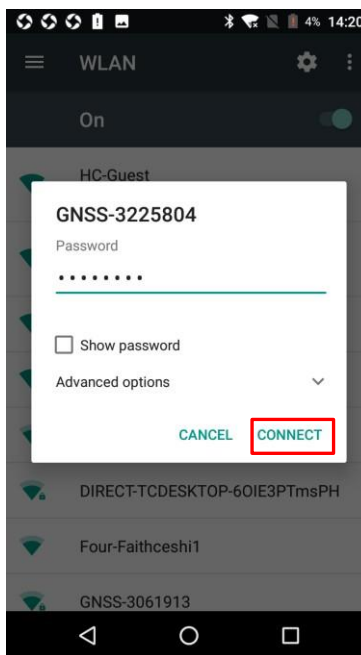

Tip – The Wi-Fi key of the receiver is 12345678 by default.

Tap the **Connect** button to build the connection.

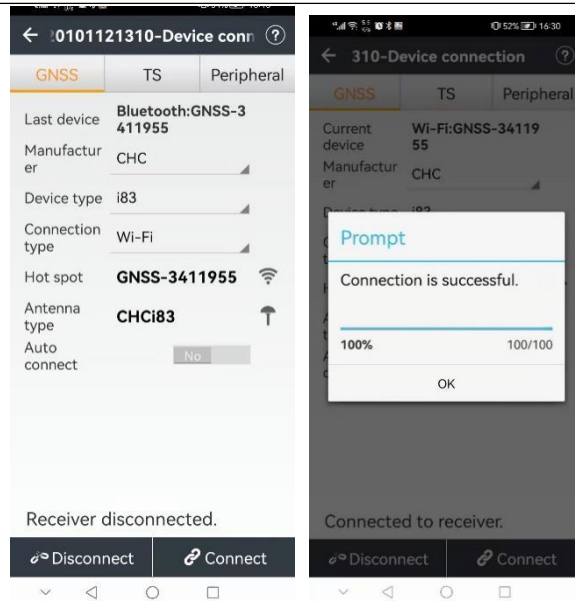

### 2.7.2 Connecting via Bluetooth with LandStar 7 Software

Turn on the controller → run LandStar 7 → go to **Config** main menu → tap **Connect**.

In the *Connect* screen, select **CHC** for the *Manufacturer* field, **i83** for *Device Type* field, **Bluetooth** for *Connection Type* field.

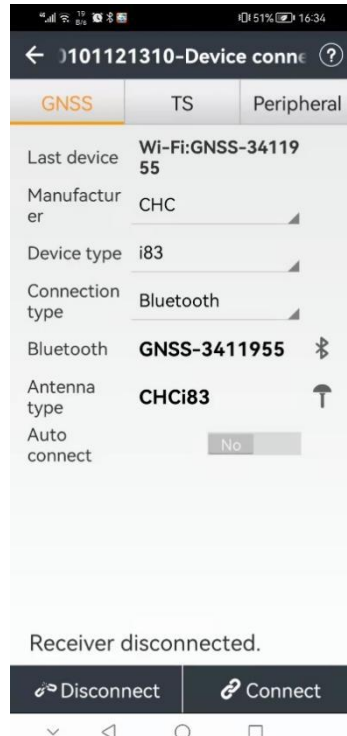

Tap the **Bluetooth Manager** and turn on the **Bluetooth** function to search Bluetooth device around → select the target device in the list → Tap back button → select the target device in the Bluetooth manager list.

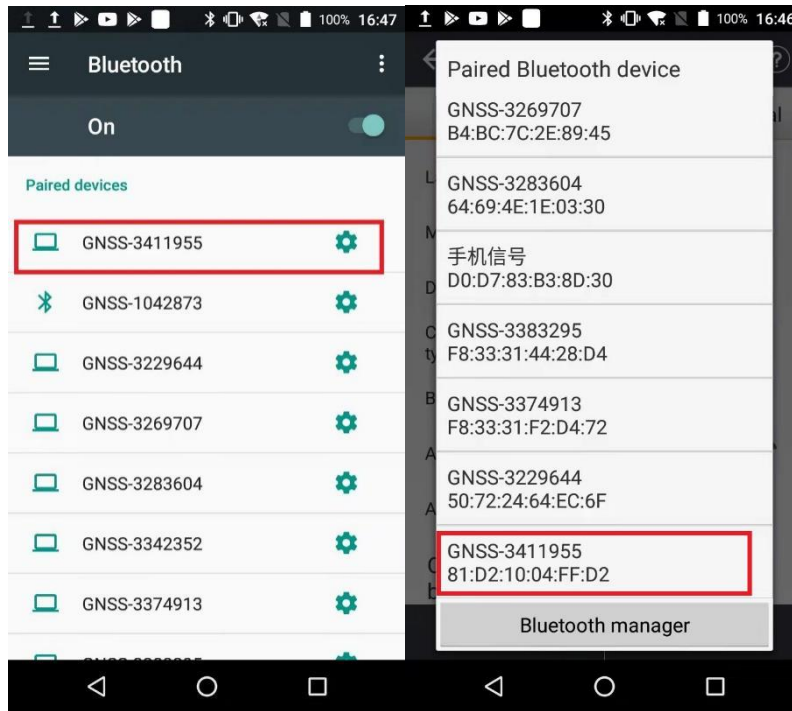

Tap the **Connect** button to build the connection.

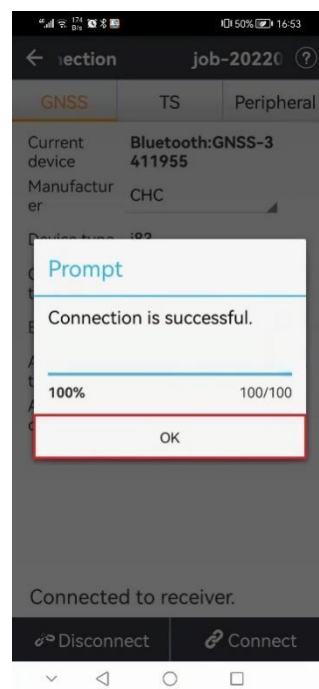
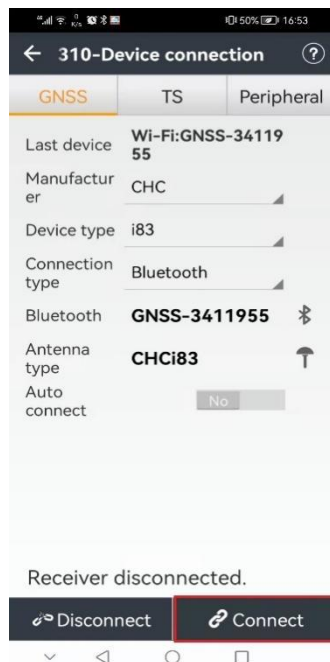

## 2.8 Downloading Logged Data

Data logging involves the collection of GNSS measurement data over a period at a static point or points, and subsequent post-processing of the information to accurately compute baseline information. Data logging using receivers requires access to suitable GNSS post-processing software such as the CHC Geomatics Office (CGO) Software.

### 2.8.1 FTP Download

The procedures of downloading logged data through FTP are as follows:

- (1) Switch on the receiver, search its Wi-Fi in the computer and connect.
- (2) After the successful connection, open the file manager in the computer and input “ftp://192.168.1.1” in the address box.

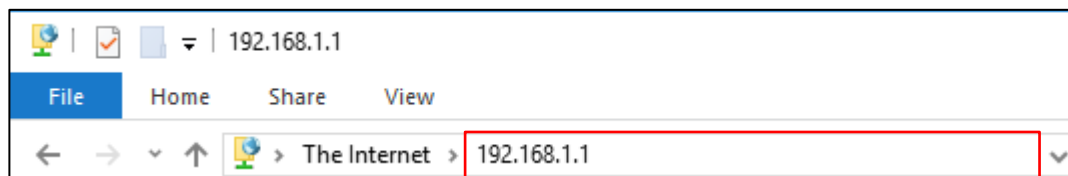

- (3) Input user name and password, the default user name and password are “ftp”.

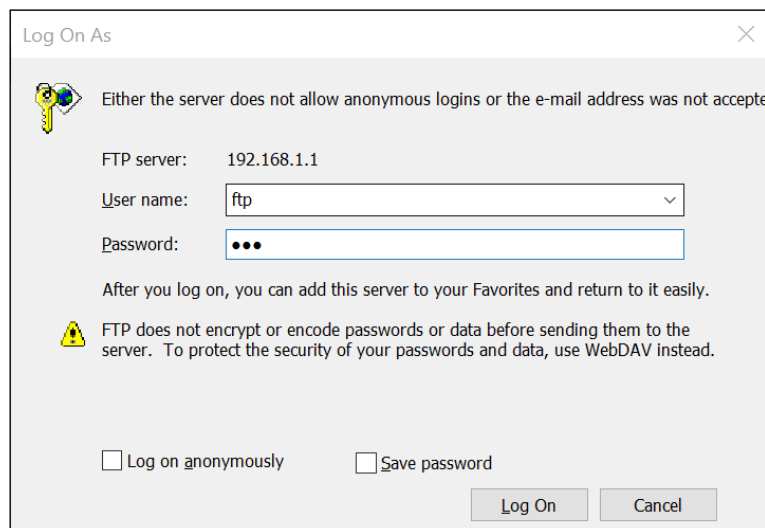

- (4) Double click the folder “repo\_receiver SN” (take 3411955 as example), you will see 9 folders. The “push\_log” folder is used to save the log files, and the other 8 folders represent different logging sessions and are used for store static data.

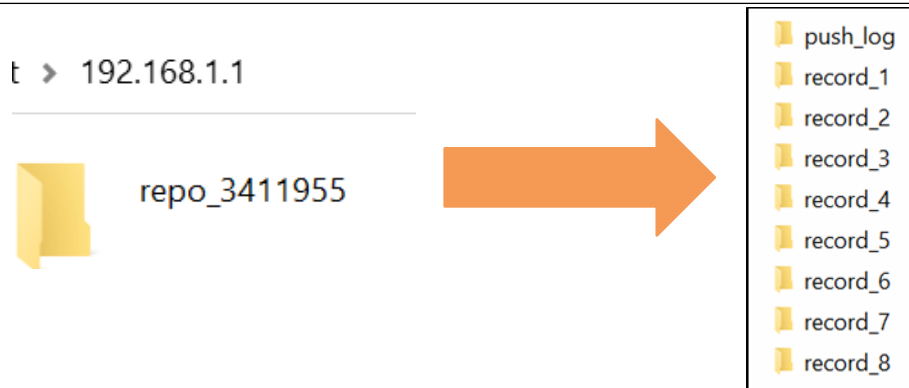

(5) Double click the folder that you have configured to store the static data, you will see the folder(s) created by the i83 system automatically and named by the date which is decided by GPS time when you start to log data.

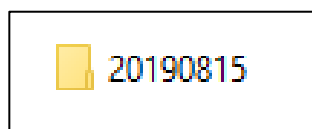

(6) Select the destination folder and double click it, two folders named as different data format (hcn and rinex) will be displayed.

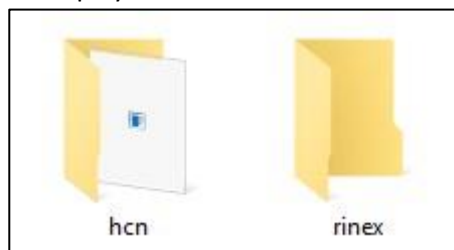

(7) Select the data format that you configured to save the static data, you will find the static raw data.

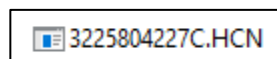

**Notes:** For hcn files, the name of the file is represented as XXXXXXDDDNN, where XXXXXX is the SN of the receiver, DDD is day of year, and NN is the recording session.

 **WARNING** – The static data will be saved in the first logging session, the “record\_1” folder, by default. Old files will be deleted if the storage space is full. If you configure not to auto delete old files when the memory is low, the receiver will stop data logging.

## 2.8.2 Web Server Download

The procedures of downloading logged data through web server refer to [5.4.4 Data Download Submenu](#).

### 2.8.3 USB Download

The procedures of downloading logged data in the receiver are as follows:

(1) Switch on the receiver and connect it with a computer by HCE600 Type-C. After the successful connection, a removable disk named as the Serial Number (SN) of the receiver will appear on the computer.

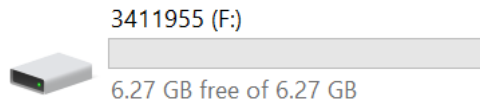

(2) Double click the removable disk and you will see the folder named as “repo”.

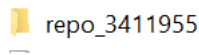

(3) Double click this folder, you will see 9 folders. The “push\_log” folder is used to save the log files, and the other 8 folders represent different logging session and are used for store

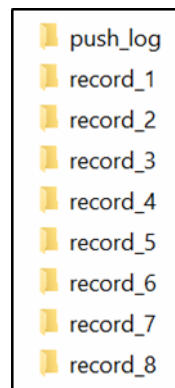

static data.

(4) Double click the folder that you have configured to store the static data, you will see the folder(s) created by the i83 system automatically and named by the date which is decide by GPS time when you start to log data.

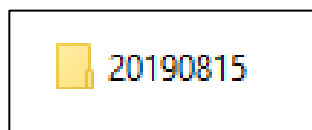

(5) Select the destination folder and double click it, and then two folders named as different data format (hcn and rinex) will be displayed.

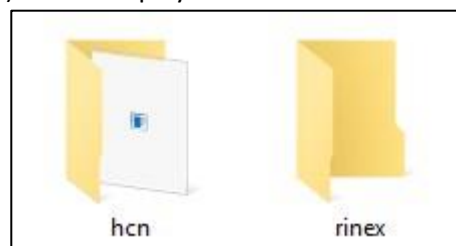

(6) Select the data format that you have configured to save the static data, you will find the

---

static raw data.

 3225804227C.HCN

Tip – For hcn files, the name of the file is represented as XXXXXDDDNN, where XXXXX is the SN of the receiver, DDD is day of year, and NN is the recording session.



WARNING – The static data will be saved in the first logging session, the “record\_1” folder, by default. Old files will be deleted if the storage space is full. If you configure not to auto delete old files when the memory is low, the receiver will stop data logging.

### 3 Front Panel Operation

The front panel contains one LCD screen, two indicator LEDs, and two buttons. The operating controls are all located on the front panel.

#### 3.1 Main Operation Menus

The top-level menu of the front panel includes 6 parts: Info, SV, Mode, Power, Data and Set. Info is the basic information of firmware such as SN, PN and etc. SV is the display of satellite situation. Mode is the important part which illustrate the work mode and users can select the mode according to their needs. Power shows the electric quantity of two batteries. Data is used to set static mode and Set is to set the device according to personal habits including language, brightness, etc.

The details of main operation are as follows and they are concluded two tables. The first table includes 5 parts: Info, SV, Power, Data and Set and the second table displays details of Data.

Top-level Menu	Second-level Menu	Description
Info	SN 3411956 PN A19318-430901-060002 -015701 -020104 Version 2.0.7 Register 2030/12/31 Static off Sample 5S Format HCN Diff Age 0.0S Network No Sim Card IMEI 861529049455435	Describe the main information of this machine. SN displays the Serial Number of the receiver. PN displays the Part Number of the receiver. Version displays the firmware version. Register displays the expiry date of registration code. Static displays if the static is on or not. Format displays the data type. Network displays the if a sim card inserts the RTK. IMEI is International Mobile Equipment Identity which is used to identify the RTK.
SV	Total: 30/30 GPS: 10/10 BDS: 10/10 GLO: 4/6 GAL: 4/4	Indicate the total number of satellites that have been tracked and the number of satellites tracked of each constellation, where BDS represents BeiDou, GLO represents GLONASS, and GAL represents Galileo.

Power	Power 95%	Indicates the remaining power of the battery
Set	Brightness High	Press Enter to select the brightness including High, Medium and low.
	Standby Time 10s	Press Enter to select standby time including 5s, 10s, 30s, 1min, 30min
	Sleep Time 1min	Press Enter to select sleep time including 5s, 10s, 30s, 1min, 30min
	WIFI ON	Press Enter to turn on or turn off WIFI.
	WIFI Mode AP	Press Enter to change the WIFI Mode including AP or STA. (The function is unavailable when WIFI is off)
	4G SIM	Press Enter to change the 4G status including eSIM or SIM.
	Channel Detection	Only work on rover mode.
	OEM Board Reset	Press Enter to reset board.
	Language English	Press Enter to change languages (English or Chinese).
	Voice Off	Press Enter to turn on or turn off voice.
	Back	Press Enter to back to last page.
Mode	Base External UHF Base Internal UHF Base APIS Base External UHF & APIS Rover APIS Rover UHF Rover NTRIP Back	<ul style="list-style-type: none"> <li>• Press Enter button to enter the configuration screen of the selected working mode.</li> <li>• More operation information, see <a href="#">3.2 Configure the Working Mode</a>.</li> </ul>

The details of Data operations are as follows:

Top-level Menu	Second-level Menu	Description
Data	Set on/off	Press Enter button to switch static measurement on or off.
	Recording 00:00	Display the time of recording
	Advanced	Sample

	Elev Mask 10 degree	Press Enter button to change the mask degree from 0 degree to 90 degrees.
	Duration 1440min	<ul style="list-style-type: none"> <li>• Press Enter button to enter Duration Time Setting screen.</li> <li>• In the Duration Time Setting screen, press Fn button to move to the character of the duration time value user want to make change, and then press Enter button to change from 0 to 9. After the change has been done, user can press Fn button to move to OK field, and then Press Enter button to save the change and back to the second-level menu; or press Fn button to move to Cancel field and press Enter button to cancel the change and back to the second-level menu.</li> </ul>
	Measurement phase Center	Press Enter button and switch height between oblique, vertical, phase center.
	Antenna Height 0.0000m	Press Enter button and input the measured antenna height.
	Format HCN	Press Enter button and switch data format between HCN, HRC, Rinex2.11 and Rinex3.02.
	Ok	Press Enter to complete settings.
	Cancel	Press Enter button to back to the last menu.
	OK	Press Enter to complete settings.
	Cancel	Press Enter button to back to the top-level menu.

### 3.2 Configure the Working Mode

7 working modes are provided for quickly setting up an RTK base station or rover station. Users can configure each working mode through the front panel as follows:

Top-level Menu	Second-level Menu	Description
Base External UHF	Mode Base External UHF	<b>The title of this configuration screen.</b>
	Format CMR	<b>Press Enter to select correction format (RTD, CMR, RTCMv2.3, RTCMv3 and RTCMv3.2).</b>
	OK	<b>Press Enter button to save the settings and back to the top-level menu, and then this working mode can take effect.</b>
	Cancel	<b>Press Enter button to cancel the settings and back to the second-level menu.</b>
Base Internal UHF	Mode Base External UHF	<b>The title of this configuration screen.</b>
	Protocol CHC	<b>Press Enter to select current protocol (CHC, Transparent, TT450s)</b>
	Channel 1 456.0500	<b>Press Enter to change the channel from 0 to 9</b>
	Baud 9600	<b>Press Enter to select Baud (4800, 9600 and 19200)</b>
	Power 1w	<b>Press Enter button to change the transmitting power (0.5w,1w,2w).</b>
	Format CMR	<b>Press Enter to select correction format (RTD, CMR, RTCMv2.3, RTCMv3 and RTCMv3.2).</b>
	OK	<b>Press Enter button to save the settings and back to the top-level menu, and then this working mode can take effect.</b>
	Cancel	<b>Press Enter button to cancel the settings and back to the second-level menu.</b>
Base APIS	Mode Base APIS	<b>The title of this configuration screen.</b>

	Format CMR	Press Enter to select correction format (RTD, CMR, RTCMv2.3, RTCMv3 and RTCMv3.2).
	IP 111.111.111.1	Press Enter to enter third-level menu to select IP (APIS1.huace.cn, APIS2.huace.cn, 211.144.120.97, 101.251.112.206) or press Customized IP to customize your own IP
	Port 9901	Press Enter button to change the port from 9901 to 9920.
	OK	Press Enter button to save the settings and back to the top-level menu, and then this working mode can take effect.
	Cancel	Press Enter button to cancel the settings and back to the second-level menu.
Base External UHF & APIS	Mode Base External UHF & APIS	The title of this configuration screen.
	Way External UHF+APIS	Display the way of base station combination.
	Format CMR	Press Enter to select correction format (RTD, CMR, RTCMv2.3, RTCMv3 and RTCMv3.2).
	IP 111.111.111.1	Press Enter to enter third-level menu to select IP (APIS1.huace.cn, APIS2.huace.cn, 211.144.120.97, 101.251.112.206) or press Customized IP to customize your own IP
	Port 9901	Press Enter button to change the port from 9901 to 9920.
	OK	Press Enter button to save the settings and back to the top-level menu, and then this working mode can take effect.
	Cancel	Press Enter button to cancel the settings and back to the second-level menu.

Rover APIS	Mode Rover APIS	<b>The title of this configuration screen.</b>
	Base ID 1234567	<b>Press Enter to enter third-level menu to change Base ID</b>
	IP 210.14.66.58	<b>Press Enter to enter third-level menu to select IP (APIS1.huace.cn, APIS2.huace.cn, 211.144.120.97, 101.251.112.206) or press Customized IP to customize your own IP</b>
	Port 9902	<b>Press Enter button to change the port from 9901 to 9920.</b>
	OK	<b>Press Enter button to save the settings and back to the top-level menu, and then this working mode can take effect.</b>
	Cancel	<b>Press Enter button to cancel the settings and back to the second-level menu.</b>
Rover UHF	Mode Rover UHF	<b>The title of this configuration screen.</b>
	Protocol CHC	<b>Press Enter to select current protocol (CHC, Transparent, TT450s)</b>
	Channel 1 456.0500	<b>Press Enter to change the channel from 0 to 9</b>
	Baud 9600	<b>Press Enter to select Baud (4800, 9600 and 19200)</b>
	OK	<b>Press Enter button to save the settings and back to the top-level menu, and then this working mode can take effect.</b>
	Cancel	<b>Press Enter button to cancel the settings and back to the second-level menu.</b>
Rover NTRIP	Mode Rover NTRIP	<b>The title of this configuration screen.</b>
	Status Not Login in in	<b>Indicates the login status.</b>

	OK	Press Enter button to save the settings and back to the top-level menu, and then this working mode can take effect.
	Cancel	Press Enter button to cancel the settings and back to the second-level menu.
Back		Press Enter button to back to the top-level menu.

## 4 Equipment Setup and Operation

### 4.1 Post-processing Base Station Setup

For good performance, the following base station setup guidelines are recommended:

**Components:**

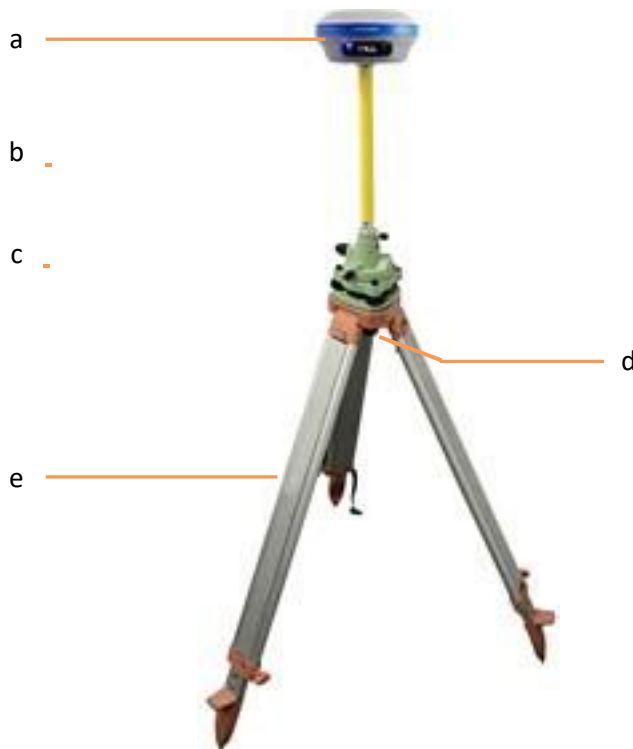

No.	Name
a	i83 GNSS receiver
b	Extension pole (30 cm)
c	Tribrach adaptor
d	Tribrach w/ Opti
e	Aluminum tripod

**Steps:**

- (1) Put tripod in the target position, center and level it roughly.
- (2) Place and lock the tribrach in the tripod.

- (3) Screw the receiver onto the tribrach.
- (4) Center and level the receiver more precisely.
- (5) Connect the receiver to external battery by using external power cable if necessary.
- (6) Connect the receiver to external storage disk by using USB cable if necessary.
- (7) Turn on the receiver by pressing the power button for 3 s.
- (8) Measure the antenna height by using H.I. tape and auxiliary H.I. tool.
- (9) Press the function button to select Data to start recording static raw.

**If work with a data controller:**

- (10) Switch on the data controller and connect it to the receiver.
- (11) Use software to configure the receiver as static mode.

## 4.2 Real-Time Base Station Setup

### 4.2.1 Internal Cellular or UHF

For good rover operation, the following base station setup guidelines are recommended:

**Components:**

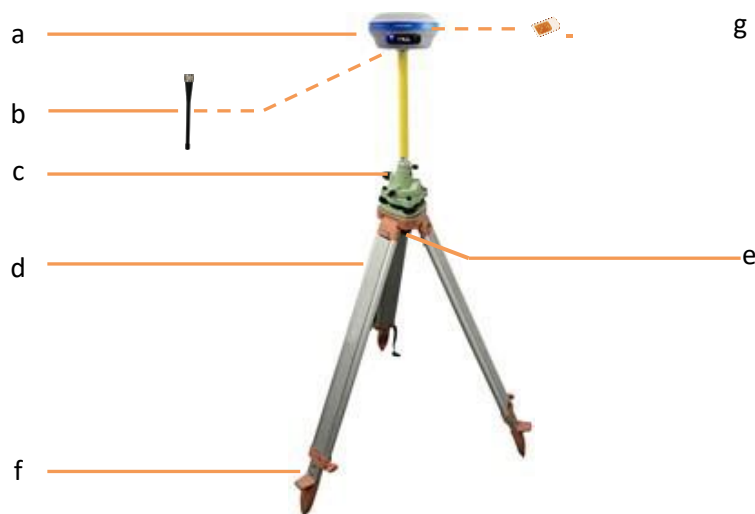

No.	Name
a	i83 GNSS receiver
b	UHF whip antenna
c	Extension pole (30 cm)
d	Tribrach adaptor
e	Tribrach w/ Opti
f	Aluminum tripod
g	Micro SIM card (12 mm x 15 mm)

**Steps:**

- (1) Put tripod in the target position, center and level it roughly.
- (2) Place and lock the tribrach in the tripod.

**If work as a cellular base station**, the SIM card need to be inserted

- (3) Screw the receiver onto the tribrach.
- (4) Center and level the receiver more precisely.

**If work as a UHF base station**, the UHF whip antenna need to be connected to the receiver.

- (5) Connect the receiver to external battery by using external power cable if necessary.
- (6) Connect the receiver to external storage disk by using USB cable if necessary.
- (7) Turn on the receiver by pressing the power button for 3 s.
- (8) Measure the antenna height by using H.I. tape and auxiliary H.I. tool.
- (9) Switch on the data controller and connect it to the receiver.
- (10) Use software to configure the receiver as cellular base or UHF base mode.

### 4.2.2 External UHF

For good performance, the following base station setup guidelines are recommended:

**Components:**

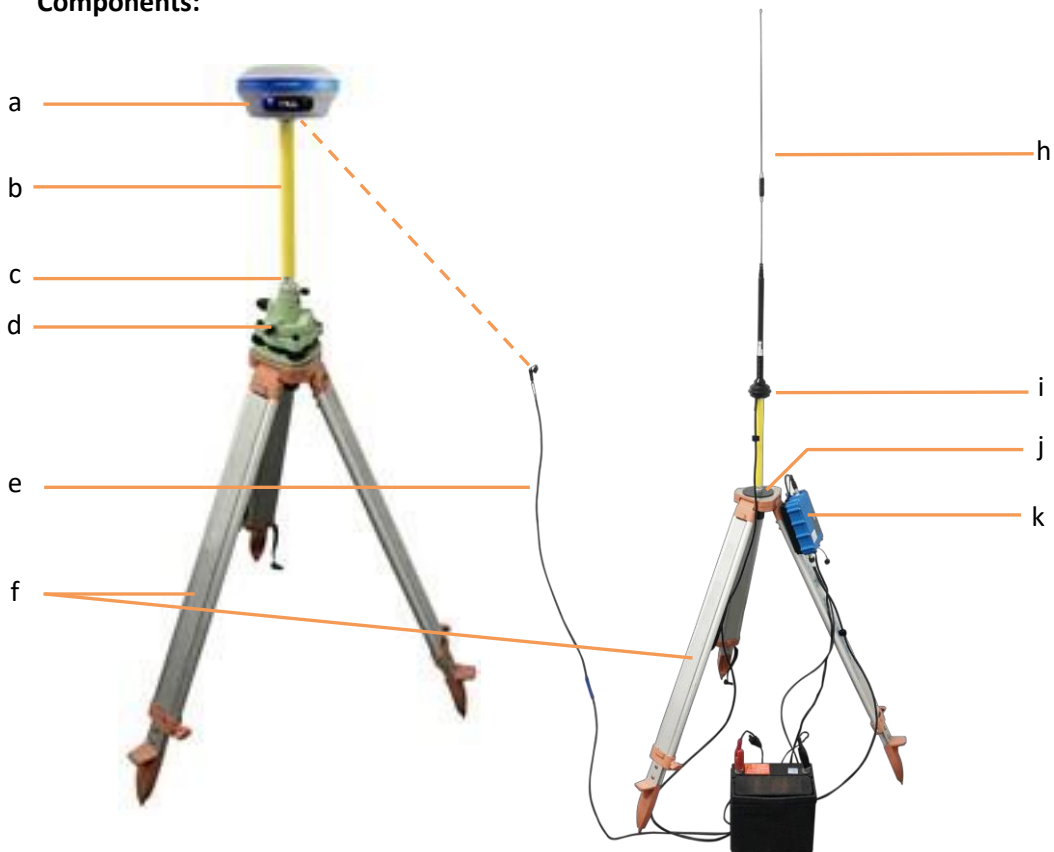

No.	Name
a	i83 GNSS receiver
b	Extension pole (30 cm)
c	Tribrach adaptor
d	Tribrach w/ Opti
e	GPS to datalink cable (power cable)
f	Aluminum tripod
h	Whip antenna
i	3 m cable for datalink antenna 3m
j	Pole mounting
k	External 410-470 datalink

**Steps:**

- (1) Put tripod in the target position, center and level it roughly.
- (2) Place and lock the tribrach in the tripod.
- (3) Screw the receiver onto the tribrach.
- (4) Center and level the receiver more precisely.
- (5) Connect the receiver to external datalink by using GPS to datalink cable.
- (6) Hang the external datalink on the tripod leg.
- (7) Connect the receiver to external battery by using external power cable if necessary.
- (8) Connect the receiver to external storage disk by using USB cable if necessary.
- (9) Turn on the receiver by pressing the power button for 3 s.
- (10) Measure the antenna height by using H.I. tape and auxiliary H.I. tool.
- (11) Turn on the external datalink and configure it as need.

**If work with a data controller:**

- (12) Switch on the data controller and connect it to the receiver.
- (13) Use software to configure the receiver as cellular base or UHF base mode.

### 4.3 Real-Time Rover Station Setup

For good performance, the following rover station setup guidelines are recommended:

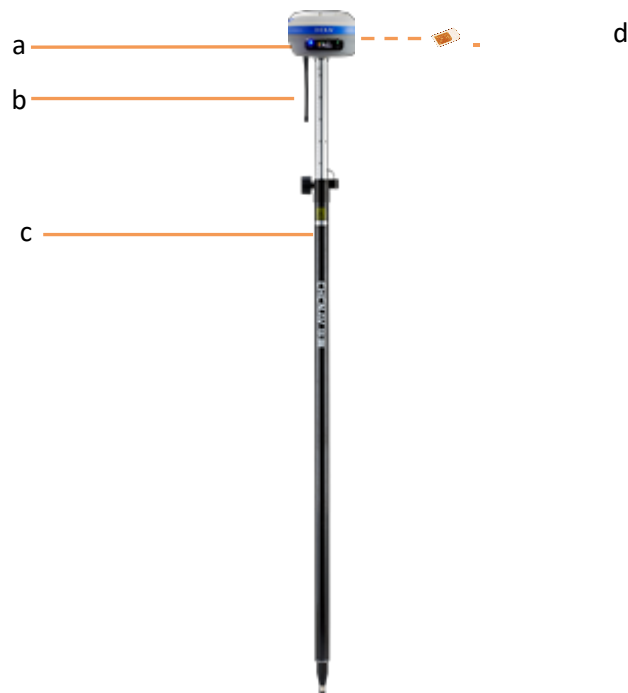
**Components:**

No.	Name
a	i83 GNSS receiver
b	whip antenna
c	2M range pole w/bag
d	Micro SIM card (12 mm x 15 mm)

**Steps:**

(1) Insert the batteries into the receiver.

**If work as a cellular rover station**, the SIM card need to be inserted before the batteries.

(2) Screw the receiver onto the pole.

**If work as a UHF rover station**, the UHF whip antenna need to be connected to thereceiver.

(3) Turn on the receiver by pressing the power button for 3 s.

(4) Switch on the data controller and connect it to the receiver.

(5) Use software to configure the receiver as cellular rover or UHF rover mode.

(6) Center and level the receiver more precisely.

(7) Use software to start survey.

## 4.4 Working with the Tilt Compensation

### 4.4.1 Operation Steps

(1) Open Landstar7-> Tap PT Survey-> Tap  to activate tilt measurement.

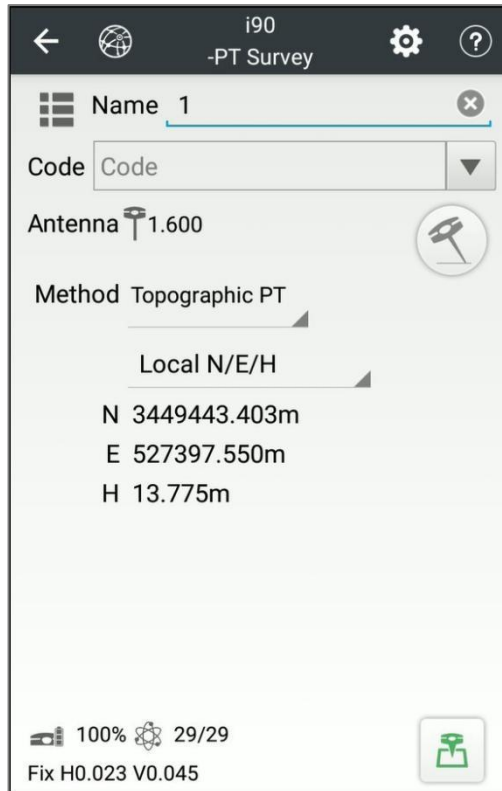

(2) Hold the pole vertical for a while and shake according to the procedures in the interface to do initialization.

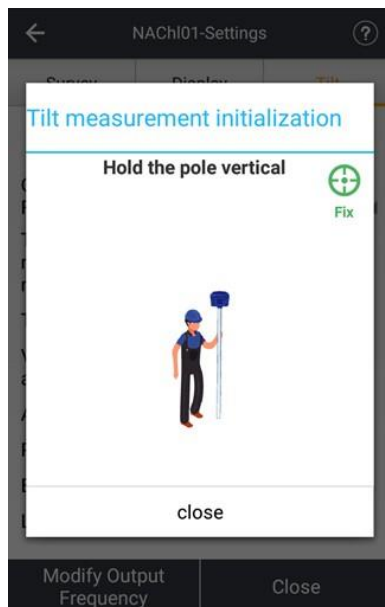

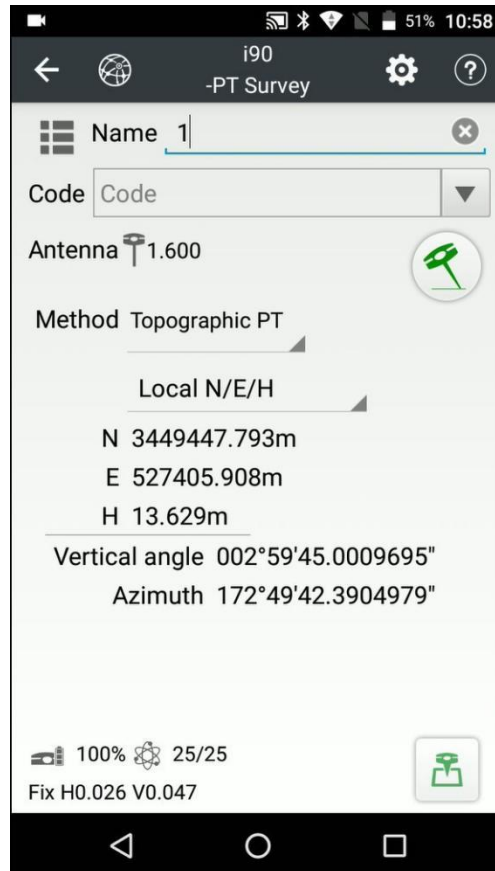

(3) This icon  will appear when the initialization is successful.

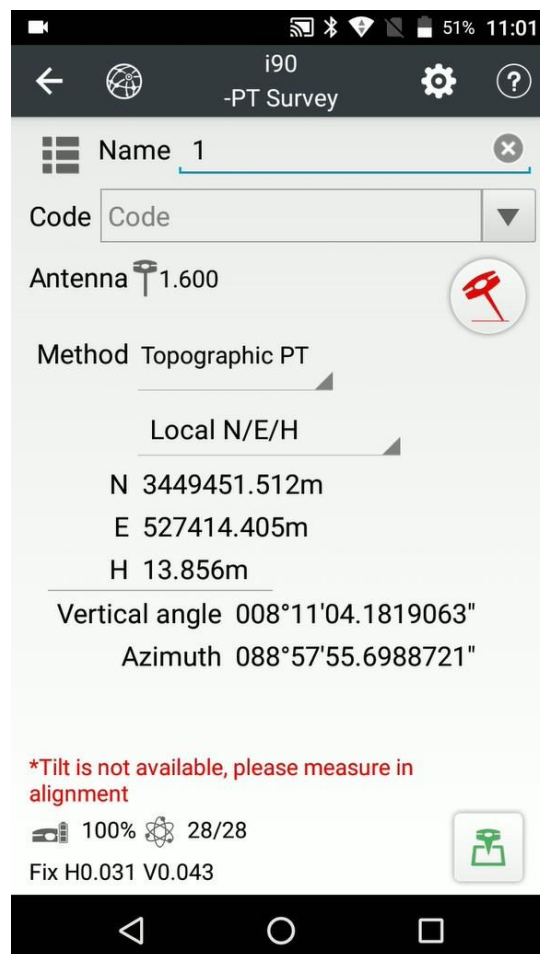

(4) Enter the Name and Antenna, then tap  point will be collected and store to Points automatically.

(5) When this icon  appears, the text will show “Tilt is not available, please measure in alignment” at the bottom of interface.



(6) Tap  to close tilt compensation.

#### 4.4.2 Notes of using tilt measurement

1. At the beginning of initialization, the pole height of the instrument should be the same as that antenna height in the software.
2. In the process of tilt measurement, if the controller shows that “Tilt is not available, please measure in alignment” (red), please shake RTK slightly from left to right or back to front until the reminder disappears.
3. The controller will prompt “Tilt is not available, please measure in alignment” when the receiver is stationary over 30 seconds or the pole hit the ground toughly.
4. The pole cannot be shaken when point is collected.
5. Initialization is required:
  - when the RTK is turned on every time;
  - when IMU module is turned on every time;

- when receiver drops at working;
- when the pole is tilted more than 65 degree;
- when the receiver is stationary more than 10 minutes;
- when the RTK rotates too fast on the matching pole (2 rounds per second);
- when the pole hit the ground toughly.

## 5 Configuring Through a Web Browser

Supported browsers:

- Google Chrome
- Microsoft Internet Explorer® version 10, or higher

To connect to the receiver through a web browser:

1. Turn on the Wi-Fi of the receiver.
2. Search the wireless network named as GNSS-XXXXXXX (the SN of your receiver) on your computer, and then establish the connection.
3. After the successful connection between your computer and the receiver, enter the IP address (192.168.1.1) of the receiver into the address bar of the web browser on your computer:

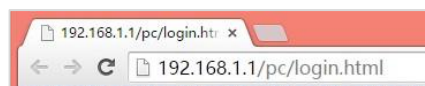

4. The web browser prompts you to enter a login account and password:



The default login account for the receiver is:

- Login Account: admin
- Password: password

**Note** – Tick **remember me** option, and then the browser will remember the Login Account and Password you entered.

5. Once you log in, the web page appears as follows:

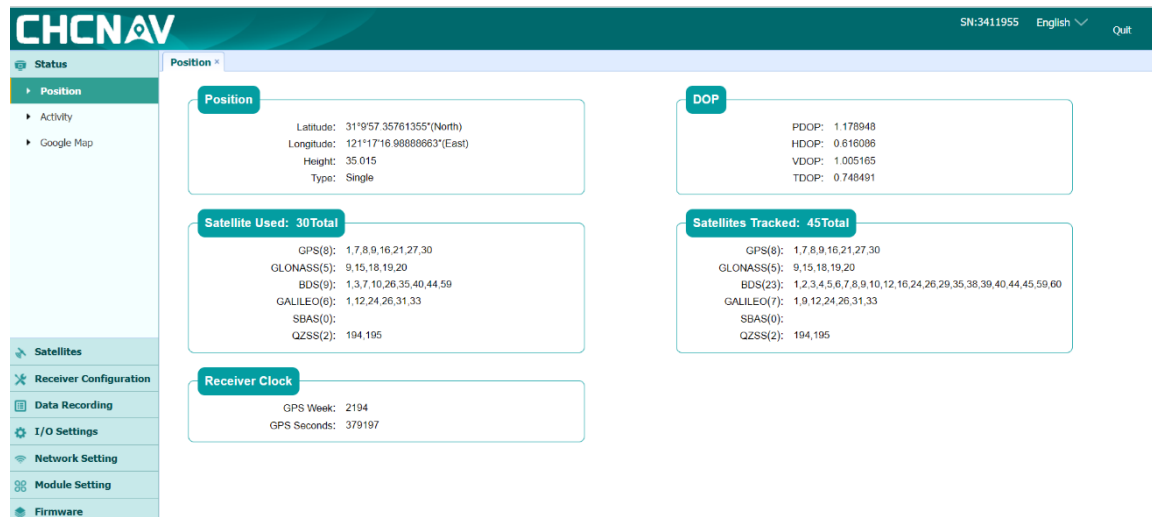

This web page shows the configuration menus on the left of the browser window, and the setting on the right. Each configuration menu contains the related submenus to configure the receiver and monitor receiver performance.

This chapter describes each configuration menu.

To view the web page in another language, select the corresponding language name from the dropdown list on the upper right corner of the web page.

Currently, two languages are available:

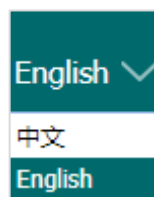

## 5.1 Status Menu

This menu provides a quick link to review the receiver's position information, satellites tracked, runtime, current data log status, current outputs, available memory, and more.

### 5.1.1 Position Submenu

This page shows the relevant position information about the receiver's position solution which including the position, DOP values, satellites used and tracked, and the receiver clock information.

**Position**

Latitude: 31°9'57.36875055"(North)  
 Longitude: 121°17'16.97717278"(East)  
 Height: 35.999  
 Type: Single

**DOP**

PDOP: 1.172767  
 HDOP: 0.616858  
 VDOP: 0.997431  
 TDOP: 0.744274

**Satellite Used: 30Total**

GPS(7): 1,7,8,9,21,27,30  
 GLONASS(5): 9,15,18,19,20  
 BDS(10): 1,3,7,9,10,26,35,40,44,59  
 GALILEO(6): 1,12,24,26,31,33  
 SBAS(0):  
 QZSS(2): 194,195

**Satellites Tracked: 45Total**

GPS(8): 1,7,8,9,16,21,27,30  
 GLONASS(5): 9,15,18,19,20  
 BDS(23): 1,2,3,4,5,6,7,8,9,10,12,16,24,26,29,35,38,39,40,44,45,59,60  
 GALILEO(7): 1,9,12,24,26,31,33  
 SBAS(0):  
 QZSS(2): 194,195

**Receiver Clock**

GPS Week: 2194  
 GPS Seconds: 379271

### 5.1.2 Activity Submenu

Lists several important items to help you understand how the receiver is being used and its current operating condition. Items include the identities of currently tracked satellites, internal and external storage usage rate, how long the receiver has been operational, state of the internal battery, power source state, files being logged, and data streams being output. With this information, it is easy to tell exactly what functions the receiver is performing

**Status**

- ▶ Position
- ▶ Activity
- ▶ Google Map

**Activity** ×

**Satellites Track: 46Total**

GPS(8): 1,7,8,9,16,21,27,30  
 GLONASS(5): 9,15,18,19,20  
 BDS(23): 1,2,3,4,5,6,7,8,9,10,12,16,24,26,29,35,38,39,40,44,45,59,60  
 GALILEO(7): 1,9,12,24,26,31,33  
 SBAS(0):  
 QZSS(3): 193,194,195

**Activity Status**

Current Time: 2022-01-27 09:21:39 (UTC)  
 Operation Duration: 00-00-00 01:20:50  
 Internal Storage:  4.85% 368MB/7595MB  
 External Storage:  0% Disconnected  
 External Power: Disconnected  
 Battery:  46%

Recording Number	File Name	Activated	Log Status
1	record1	Yes	Recording
2	record2	No	Not Recording
3	record3	No	Not Recording
4	record4	No	Not Recording
5	record5	No	Not Recording
6	record6	No	Not Recording
7	record7	No	Not Recording
8	record8	No	Not Recording

	Type	Description	Output
1	RTX Client	211.144.118.5 2102	--
2	TCP/UDP_Client1NTRIP Server1	192.168.3.18 9900	--
3	TCP/UDP_Client2NTRIP Server2	192.168.3.18 9901	--
4	TCP/UDP_Client3NTRIP Server3	192.168.3.18 9902	--
5	TCP/UDP_Client4NTRIP Server4	192.168.3.18 9903	--
6	TCP/UDP_Client5NTRIP Server5	192.168.3.18 9904	--
7	TCP/UDP_Client5NTRIP Server5	192.168.3.18 9905	--
8	TCP ServerNTRIP Caster1	9901	--
9	TCP ServerNTRIP Caster2	9902	--
10	TCP ServerNTRIP Caster3	9903	--
11	TCP ServerNTRIP Caster4	9904	--
12	Serial Port	9600	--
13	Bluetooth	GNSS-3200193	--
14	Radio	460.0500MHz	--

### 5.1.3 Google Map Submenu

Tap this submenu to show the location of the receiver on Google map.

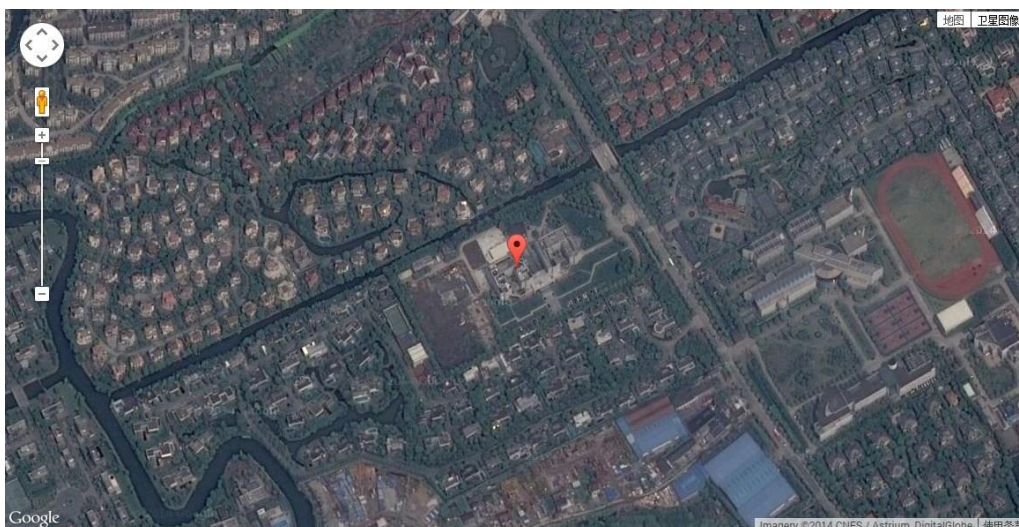

## 5.2 Satellites Menu

Use the Satellites menu to view satellite tracking details and enable/disable GPS, GLONASS, BDS and Galileo constellations. These menus include tabular and graphical displays to provide all required information on satellite tracking status.

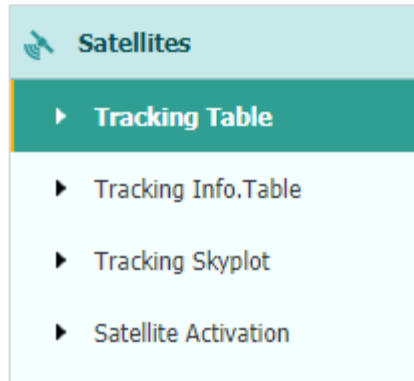

### 5.2.1 Tracking Table Submenu

Provides the status of satellites tracked in general, such as the satellite ID, satellite type, attitude angle, azimuth angle, L1 SNR, L2 SNR, L5 SNR and enable/disable status of each one.

SV	Type	Elevation Angle	Azimuth Angle	L1 SNR	L2 SNR	L5 SNR	B1C SNR	B2A SNR	Enabled
3	GPS	21	282	40.000	40.850	30.880	0.000	0.000	Yes
4	GPS	15	318	40.030	36.800	27.800	0.000	0.000	Yes
16	GPS	45	242	44.820	39.450	0.000	0.000	0.000	Yes
26	GPS	74	318	48.720	43.430	36.160	0.000	0.000	Yes
27	GPS	12	188	34.690	35.890	26.250	0.000	0.000	Yes
29	GPS	23	50	41.370	36.580	0.000	0.000	0.000	Yes
31	GPS	55	44	45.450	41.970	0.000	0.000	0.000	Yes
32	GPS	35	149	42.840	38.490	30.140	0.000	0.000	Yes
1	GLONASS	52	211	41.760	46.170	0.000	0.000	0.000	Yes
2	GLONASS	40	313	47.100	46.320	0.000	0.000	0.000	Yes
8	GLONASS	14	174	36.530	43.730	0.000	0.000	0.000	Yes
12	GLONASS	41	300	45.760	49.200	0.000	0.000	0.000	Yes
21	GLONASS	22	94	37.800	44.160	0.000	0.000	0.000	Yes
1	BDS	45	140	39.830	42.710	44.970	0.000	0.000	No
2	BDS	35	235	35.420	43.410	42.250	0.000	0.000	No
3	BDS	50	199	40.270	44.410	43.470	0.000	0.000	Yes

### 5.2.2 Tracking Info. Table Submenu

The following figure is an example of satellite track diagram page. Users can determine the satellite types and the corresponding SNR of L-band carriers to be displayed in any combination.



### 5.2.3 Tracking Skyplot Submenu

The following figure is an example of Skyplot page.

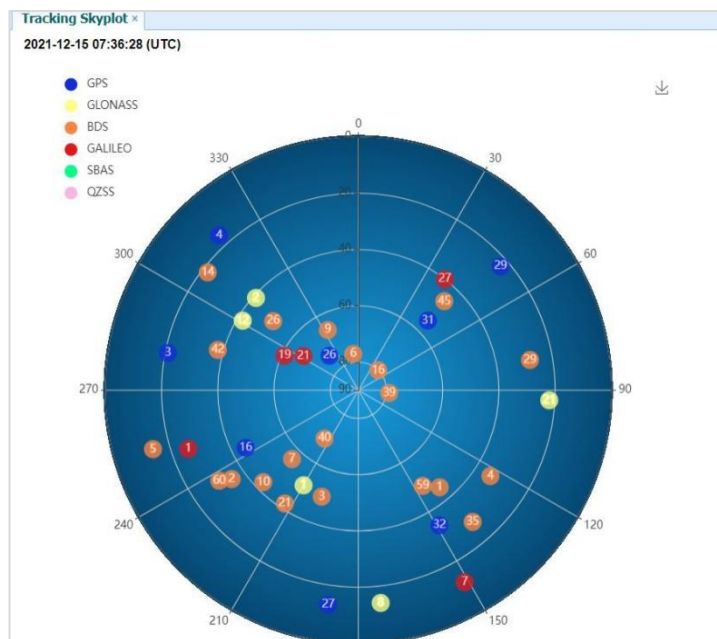

### 5.2.4 Satellite Activation Submenu

Use this menu to enable or disable satellites.



### 5.3 Receiver Configuration Menu

Use this menu to configure settings such as the antenna type and height, elevation mask and PDOP setting, the reference station coordinates, receiver resetting and web interface language:

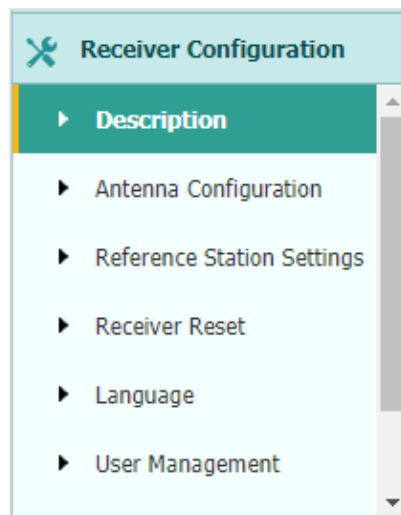

### 5.3.1 Description

This submenu shows the receiver information and reference station information, including antenna related information, elevation mask angle, reference station work mode and position, etc.

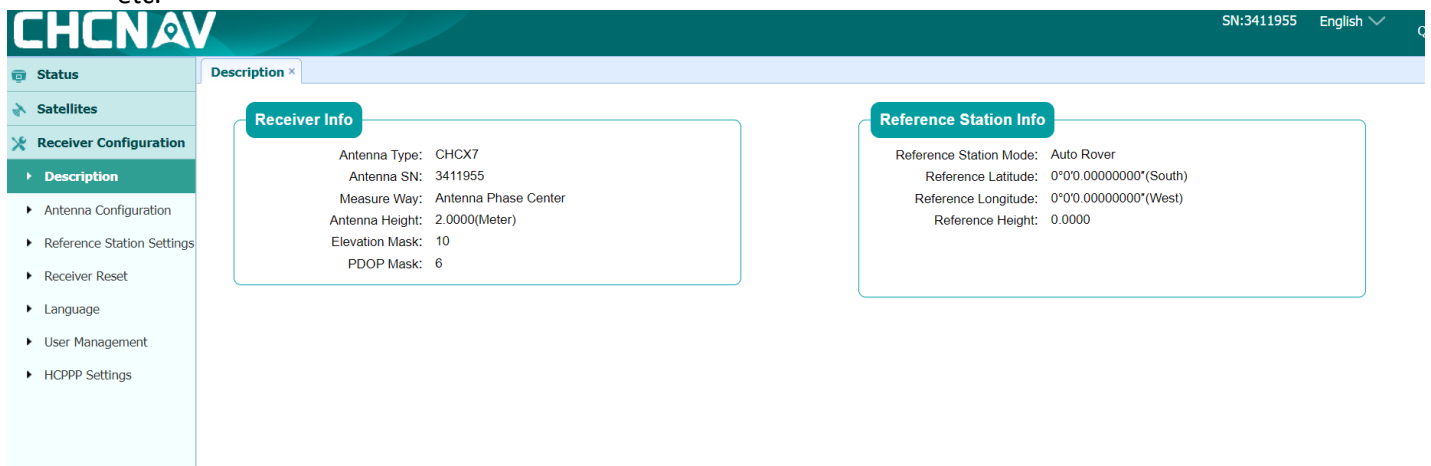

### 5.3.2 Antenna Configuration Submenu

Use this screen to configure all the items related to the GNSS antenna. You must enter the correct values for all antenna-related fields, because the choices you make affect the accuracy for logged data and broadcast correction data significantly:

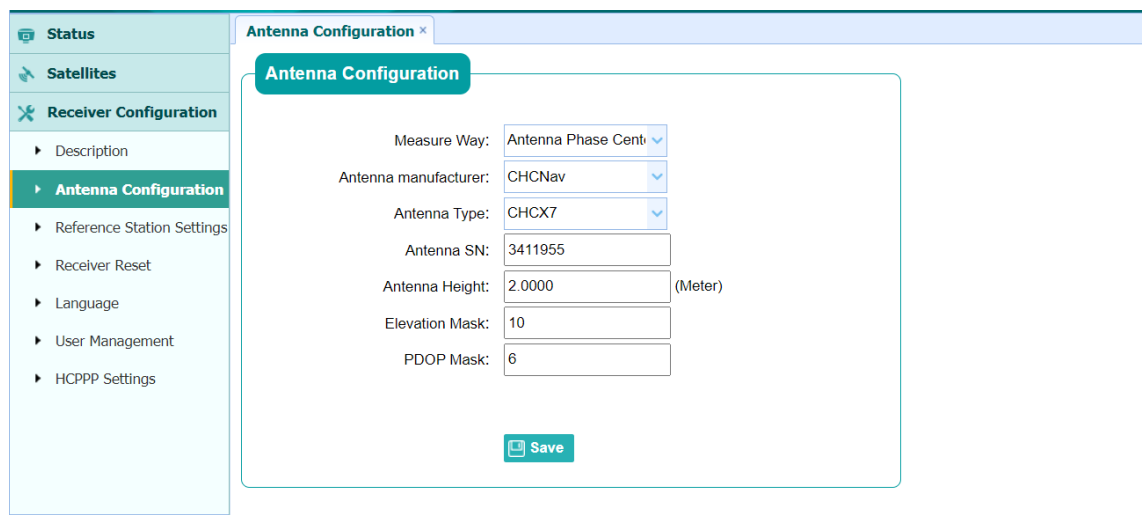

### 5.3.3 Reference Station Settings Submenu

Use this screen to configure settings such as the station coordinates and the broadcast station identifiers. You must enter accurate information in these fields, as this data affects the accuracy of logged data files and broadcast correction data significantly:

For **Reference Station Mode**:

There are three modes available:

- a) **Auto Rover**: The receiver will serve as a rover after this mode is enabled, and then receive correction data through the working mode set last time.

Reference Station Settings ×

Reference Station Mode:

 Save

**Sample for Average**

Positioning Constraint:  Single Solution Coordinates  Fixed Solution Coordinates

Sampling Amount:

 Start

 Stop

- b) **Auto Base**: The receiver will serve as a base after this mode is enabled, and then broadcast correction data based on coordinate inputted by user or obtained through autonomous positioning automatically.

**Reference Station Settings** ×

Reference Station Mode:

Base Station Name:

Base Station ID:

Reference Latitude: ° ′ ″  N  S

Reference Longitude: ° ′ ″  E  W

Reference Height:

**Sample for Average**

Positioning Constraint:  Single Solution Coordinates  Fixed Solution Coordinates

Sampling Amount:

Coordinates transfer threshold value(Meter):

**Base list**

ID	Height	Latitude			Longitude		
1	<input type="text" value="15.8174"/>	<input type="text" value="31"/>	<input type="text" value="9"/>	<input type="text" value="58.23544755"/>	<input type="radio"/> S	<input checked="" type="radio"/> N	<input type="text" value="121"/> ° <input type="text" value="17"/> ′ <input type="text" value="15.28542026"/> ″ <input type="radio"/> E <input checked="" type="radio"/> W
2	<input type="text" value="8.9960"/>	<input type="text" value="31"/>	<input type="text" value="9"/>	<input type="text" value="58.18017579"/>	<input type="radio"/> S	<input checked="" type="radio"/> N	<input type="text" value="121"/> ° <input type="text" value="17"/> ′ <input type="text" value="15.40953509"/> ″ <input type="radio"/> E <input checked="" type="radio"/> W
3	<input type="text" value="54.3043"/>	<input type="text" value="31"/>	<input type="text" value="9"/>	<input type="text" value="57.63710849"/>	<input type="radio"/> S	<input checked="" type="radio"/> N	<input type="text" value="121"/> ° <input type="text" value="17"/> ′ <input type="text" value="16.96040091"/> ″ <input type="radio"/> E <input checked="" type="radio"/> W
4	<input type="text" value="54.7207"/>	<input type="text" value="31"/>	<input type="text" value="9"/>	<input type="text" value="57.64332088"/>	<input type="radio"/> S	<input checked="" type="radio"/> N	<input type="text" value="121"/> ° <input type="text" value="17"/> ′ <input type="text" value="16.79712004"/> ″ <input type="radio"/> E <input checked="" type="radio"/> W
5	<input type="text" value="44.5090"/>	<input type="text" value="31"/>	<input type="text" value="9"/>	<input type="text" value="57.38446236"/>	<input type="radio"/> S	<input checked="" type="radio"/> N	<input type="text" value="121"/> ° <input type="text" value="17"/> ′ <input type="text" value="16.91309424"/> ″ <input type="radio"/> E <input checked="" type="radio"/> W
6	<input type="text" value="57.2322"/>	<input type="text" value="31"/>	<input type="text" value="9"/>	<input type="text" value="57.33298549"/>	<input type="radio"/> S	<input checked="" type="radio"/> N	<input type="text" value="121"/> ° <input type="text" value="17"/> ′ <input type="text" value="16.99217382"/> ″ <input type="radio"/> E <input checked="" type="radio"/> W
7	<input type="text" value="54.6052"/>	<input type="text" value="31"/>	<input type="text" value="9"/>	<input type="text" value="57.34069924"/>	<input type="radio"/> S	<input checked="" type="radio"/> N	<input type="text" value="121"/> ° <input type="text" value="17"/> ′ <input type="text" value="16.44724736"/> ″ <input type="radio"/> E <input checked="" type="radio"/> W
8	<input type="text" value="8.6995"/>	<input type="text" value="31"/>	<input type="text" value="9"/>	<input type="text" value="58.92883736"/>	<input type="radio"/> S	<input checked="" type="radio"/> N	<input type="text" value="121"/> ° <input type="text" value="17"/> ′ <input type="text" value="17.62076462"/> ″ <input type="radio"/> E <input checked="" type="radio"/> W
9	<input type="text" value="7.5335"/>	<input type="text" value="31"/>	<input type="text" value="9"/>	<input type="text" value="57.82584863"/>	<input type="radio"/> S	<input checked="" type="radio"/> N	<input type="text" value="121"/> ° <input type="text" value="17"/> ′ <input type="text" value="17.67097178"/> ″ <input type="radio"/> E <input checked="" type="radio"/> W
10	<input type="text" value="17.2042"/>	<input type="text" value="31"/>	<input type="text" value="9"/>	<input type="text" value="59.25688326"/>	<input type="radio"/> S	<input checked="" type="radio"/> N	<input type="text" value="121"/> ° <input type="text" value="17"/> ′ <input type="text" value="17.57073058"/> ″ <input type="radio"/> E <input checked="" type="radio"/> W

c) **Manual Base:** The receiver will serve neither as a base nor a rover after this mode is enabled. Users need to configure the receiver manually.

**Reference Station Settings** ×

Reference Station Mode:

Base Station Name:

Base Station ID:

Reference Latitude: ° ′ ″  N  S

Reference Longitude: ° ′ ″  E  W

Reference Height:

**Sample for Average**

Positioning Constraint:  Single Solution Coordinates  Fixed Solution Coordinates

Sampling Amount:

For **Reference Latitude** and **Reference Longitude**:

There are mainly three methods to enter the reference coordinates and shown as follows:

- a) **Acquire Current Position**: Click this button to acquire current position obtained through autonomous positioning automatically.
- b) **Manual Input**: Manually input the coordinate of a control point.
- c) **From CORS**: After the receiver logging in CORS, the software can record the coordinate of current position based on fix solution.

For **Sample for Average**:

Users can determine the positioning limit and sampling amount. The positioning limit falls into two types:

- a) **Single Solution Coordinates**: Collect the coordinates of receiver obtained through autonomous positioning.
- b) **Fixed Solution Coordinates**: Only collect coordinates of receiver with a fixed solution.

After the configuration of positioning limit and sampling amount, click **Start** to carry out sampling and averaging → the progress bar will show the progress → the result will be served as the coordinate of current position.

If users need to save the changes, please tap **Save** button.

### 5.3.4 Receiver Reset Submenu

Use this screen to completely or partially reset the receiver:

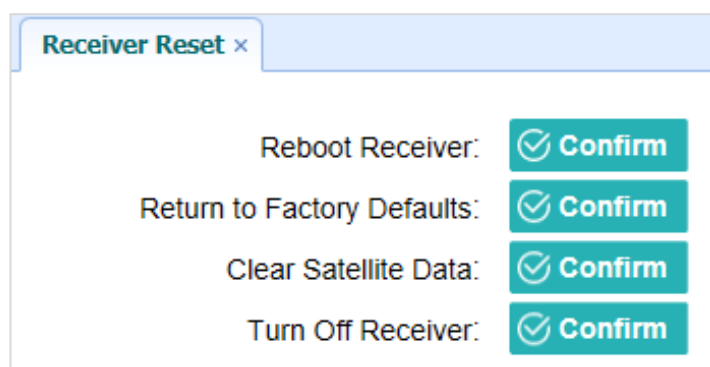

### 5.3.5 Languages Submenu

Use this screen to select the web interface language:

Language x

English
 

中文  
 English

Confirm

### 5.3.6 User Management Submenu

User Management x

User Management			
<span> Add</span> <span> Save</span> <span> Delete</span> <span> Modify Anti-theft password</span>			
ID	User Name	Password	
1	<input type="text" value="admin"/>	<input type="password" value="....."/>	
2	<input type="text" value="admin1"/>	<input type="password" value="....."/>	
3	<input type="text" value="admin2"/>	<input type="password" value="....."/>	

### 5.3.7 HCPPP Settings

HCPPP Settings x

HCPPP Range:   Save

## 5.4 Data Recording Menu

Use the Data Logging menu to set up the receiver to log static GNSS data and to view the logging settings. You can configure settings such as observable rate, recording rate, continuous logging limit, and whether to auto delete old files when memory is low. This menu also provides the controls for the FTP push feature:

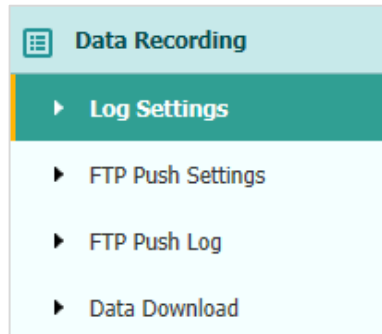

### 5.4.1 Log Settings Submenu

Here shows the data logging status, including internal and external storage usage and data

logging status of each session. Also, users can configure the data logging settings for each session, including recording name, store location, storage limit, store formats, start time, etc

Log Settings ×

Store Info			
	Position	Total Storage	Storage Available
1	Internal Storage	7595MB	7227MB
2	External Storage	0MB	0MB

6GB. It will stop recording when the storage is full.

Record Info						
Recording Number	File Name	Activated	Log Status	Setting Parameter	Switch	Clear Data
1	record1	No	Not Recording	<a href="#">Modify</a> <a href="#">Detail</a>	<a href="#">ON</a> <a href="#">OFF</a>	<a href="#">Clear</a>

[Clear All](#)

To edit the settings of each session, click the **Modify** button to the right of the required session, and then the *Recording Edit* screen appears:

Recording Edit ×

Auto Record:  Yes  No

Sample Interval:

Elevation Mask:  (°)

Duration Time:  (Minute)

Site Name:

Antenna Height:

Measure Way:

Storage Format:

RINEX Version:

[Advanced](#)

[Save](#)
[Back](#)

Click advanced to see more settings.

**Recording Edit**

Auto Record:  Yes  No

Sample Interval: 5s

Elevation Mask: 10 (°)

Duration Time: 1440 (Minute)

Site Name: 3411955

Antenna Height: 0.0000

Measure Way: Antenna Phase

Storage Format: HCN

RINEX Version: OFF

Advanced

Start Date:  Yes  No

Apply Time:  Yes  No

Integral Point Store:  Yes  No

Circulating Memory:  Yes  No

Repeat Observations:  Yes  No

the data overwritten first file after storage space is full

Turn on to record a single observation. Turn off to record repeated observations.

Store Location: Internal Storage

Assigned Storage: 6000 (MB)

Observer: CHC

Observe Agency: CHC



FTP Push:  Close  
 1:ftp server 1  
 2:ftp server 2  
 3:ftp server 3

Save Back

In this screen, you can configure all the data logging parameters, and determine whether the recording files will be affected by the FTP Push. The parameters are mainly as follows:

- **Auto Record:** on or off.
- **Sample Interval:** Select the observable rate from the dropdown list.
- **Elevation Mask:** Enter the elevation mask.
- **Duration Time:** Set the duration of data logging.
- **Site Name:** Enter the name of the site.
- **Antenna Height:** the measured height value.
- **Measure way:** Antenna Phase Center, Vertical Height, Slant Height
- **Storage Format:** Select the format of the data store.
- **RINEX Version:** OFF, 3.02, 2.11
- **Start Date:** Select **Yes** or **No** option to determine whether to auto record start date.
- **Apply Time:** Select **Yes** or **No** option to determine whether to auto record apply time.
- **Integral Point Store:** Select **Yes** or **No** option to determine whether to allow receiver to save data every hour.
- **Circulating Memory:** Select **Yes** or **No** option to determine whether to auto delete old files if the storage space is full.
- **Repeat Observations:** Select **Yes** or **No** option to determine whether to turn on to record a single observation.
- **Store Location:** Internal Storage, External Storage.
- **Assigned Storage:** The assigned memory size of current thread(for example, Record 1) is 10000MB

- **Observer:** Enter the name of observer.
- **Observer Agency:** Enter the name of observer agency.
- **FTP Push:** Decide whether to push the stored files to the FTP server of your choice.

Tap  button to save the settings and back to the *Log Settings* screen. Also, users can click  to abandon the changed settings and back to *Log Settings* screen.

**Note** – To modify data logging parameters, make sure the data logging session is switched off.

To switch on or off **ANY** data logging session, tap the **ON** or **OFF** button on the right of the required session.



To delete the recorded files of **ANY** data logging session, tap the **Clear** button on the right of the required session.

To delete the recorded files of **ALL** data logging sessions, tap the **Clear ALL Accounts** button.

### 5.4.2 FTP Push Settings Submenu

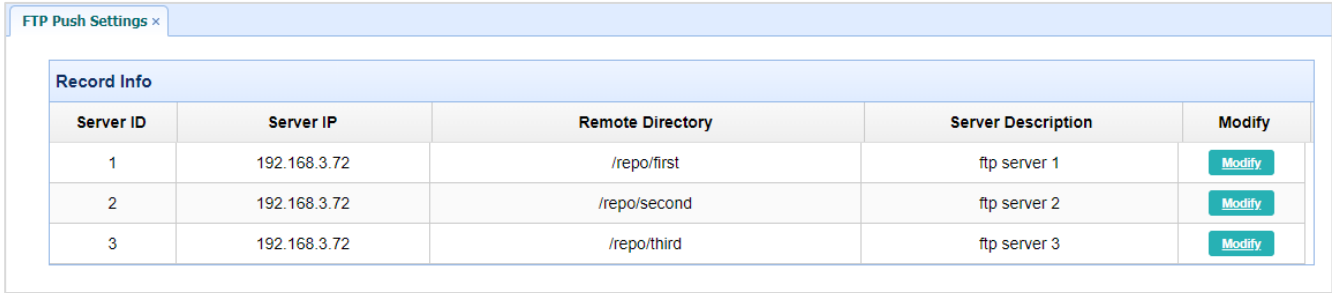
Use this screen to configure the receiver to push stored files to the FTP server of your choice. Only files that are configured to use FTP push are transmitted.



Record Info				
Server ID	Server IP	Remote Directory	Server Description	Modify
1	192.168.3.72	/repo/first	ftp server 1	
2	192.168.3.72	/repo/second	ftp server 2	
3	192.168.3.72	/repo/third	ftp server 3	

Tap **Modify** button on the right of the required FTP server and the *FTP Push Settings* screen appears:

### 5.4.3 FTP Push Log Submenu

Shows the related information about the recorded files that will be pushed. And users can tap **Clear Ftp Send Log** button in the upper right corner to clear the log of FTP Push operations.

Server ID	Push File	File Size	Push Time	Push Successful Or Not
Clear FTP Push Log				
Displaying 0 to 0 of 0 items				

### 5.4.4 Data Download Submenu

In this submenu, users can download the data files that recorded in the internal storage through the internal FTP site.

1. Click this submenu, and then the log on dialogue box will prompt you to enter a user name and password:

**Sign in**

ftp://192.168.1.1

Your connection to this site is not private

Username

Password

The default logon account for the internal FTP site is:

- User name: ftp
- Password: ftp

2. Click the directory named as “repo” to view and download the files currently stored on the receiver:

### Index of /

Name	Size	Date Modified
<a href="#">System Volume Information/</a>		8/9/19, 10:28:00 PM
<a href="#">repo_3225804/</a>		7/16/19, 1:17:00 PM

3. To find the file need to be downloaded, click the name of data logging session → the date of file that be recorded → the format of the file → the name of the target file.

### Index of /repo\_3225804/

[\[parent directory\]](#)

Name	Size	Date Modified
<a href="#">push_log/</a>		7/16/19, 1:17:00 PM
<a href="#">record_1/</a>		8/15/19, 10:22:00 AM
<a href="#">record_2/</a>		7/16/19, 1:17:00 PM
<a href="#">record_3/</a>		7/16/19, 1:17:00 PM
<a href="#">record_4/</a>		7/16/19, 1:17:00 PM
<a href="#">record_5/</a>		7/16/19, 1:17:00 PM
<a href="#">record_6/</a>		7/16/19, 1:17:00 PM
<a href="#">record_7/</a>		7/16/19, 1:17:00 PM
<a href="#">record_8/</a>		7/16/19, 1:17:00 PM

- To download a file, left click the name of the target file → download the file according to the prompts.

## 5.5 IO Settings Menu

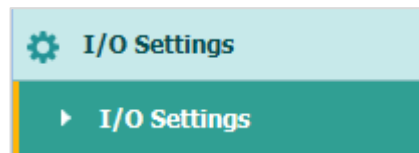

Use the IO Settings menu to set up all receiver outputs and inputs. The receiver can output CMR, RTCM, Raw data, Ephemeris data, GPGGA, GPGSV, on TCP/IP, UDP, serial port, or Bluetooth ports.

### 5.5.1 IO Settings Submenu

The following figure shows an example of the screen that appears when you select this submenu.

I/O Settings ×					
	Type	Description	Output	Connection Status	Modify
1	RTK Client	211.144.118.5:2102	---	Unconnected	Connect Disconnecting De
2	TCP/UDP_Client1/NTRIP Serv	192.168.3.18:9900	---	Unconnected	Connect Disconnecting De
3	TCP/UDP_Client2/NTRIP Serv	192.168.3.18:9901	---	Unconnected	Connect Disconnecting De
4	TCP/UDP_Client3/NTRIP Serv	192.168.3.18:9902	---	Unconnected	Connect Disconnecting De
5	TCP/UDP_Client4/NTRIP Serv	192.168.3.18:9903	---	Unconnected	Connect Disconnecting De
6	TCP/UDP_Client5/NTRIP Serv	192.168.3.18:9904	---	Unconnected	Connect Disconnecting De
7	TCP/UDP_Client6/NTRIP Serv	192.168.3.18:9905	---	Unconnected	Connect Disconnecting De
8	TCP Server/NTRIP Caster1	9901	---	Closed	Connect Disconnecting De
9	TCP Server/NTRIP Caster2	9902	---	Closed	Connect Disconnecting De
10	TCP Server/NTRIP Caster3	9903	---	Closed	Connect Disconnecting De
11	TCP Server/NTRIP Caster4	9904	---	Closed	Connect Disconnecting De
12	Serial Port	115200	---	---	Settings
13	Bluetooth	GNSS-3411955	GPGGA:5s,	---	Settings
14	Radio	462.5500MHz	---	---	Settings

In this submenu, users can configure 6 types of input and output settings.

#### 1. RTK Client

After configuring the settings of RTK client, users can log on CORS or APIS. Tap the **Connect** button to the right → the *IO Settings* screen will appear → choose one of the connection protocols among the NTRIP, APIS\_BASE and APIS\_ROVER → configure the related parameters → click **Confirm** to log on CORS or APIS.

- Connection Protocol: NTRIP

- Connection Protocol: APIS\_BASE

- Connection Protocol: APIS\_ROVER

- Connection Protocol: TCP

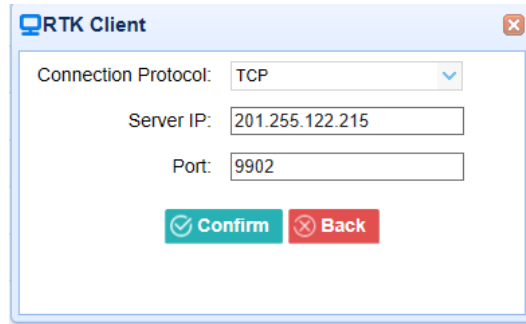

2. TCP/UDP\_Client/NTRIP Server

Tap the **Connect** button on the right of required TCP/UDP Client → the *IO Settings* screen will appear → select the connection protocol from TCP, UDP, NTRIP1.0 and NTRIP2.0 → enter the IP and Port of the target server → configure messages that you want to output to the target server → click **Confirm** to save and complete the connection.

- Connection Protocol: TCP

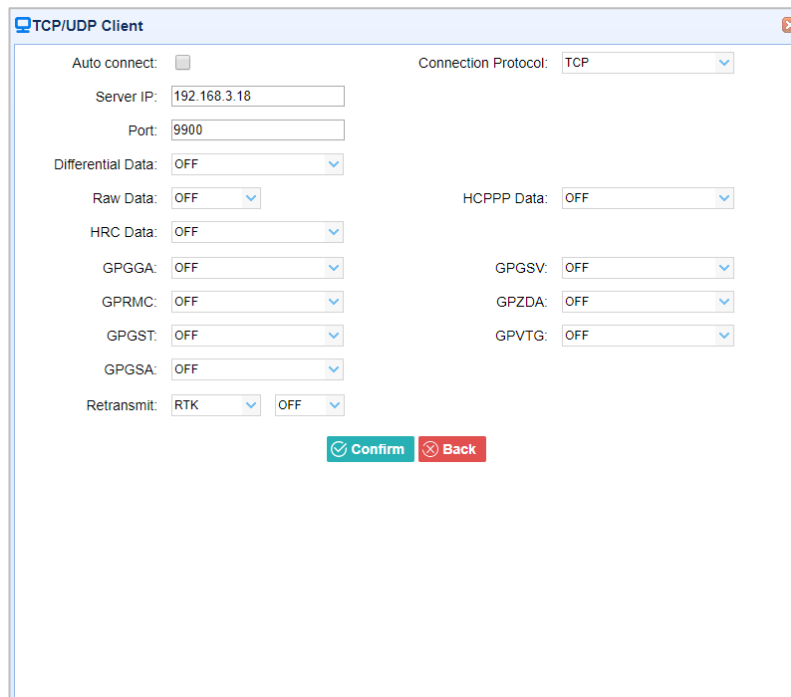

- Connection Protocol: UDP

The screenshot shows the 'TCP/UDP Client' configuration window. The 'Connection Protocol' is set to 'UDP'. The 'Server IP' is '192.168.3.18' and the 'Port' is '9900'. The 'Auto connect' checkbox is unchecked. The 'Differential Data' is set to 'OFF'. The 'Raw Data' is set to 'OFF'. The 'HRC Data' is set to 'OFF'. The 'GPSSA' is set to 'OFF'. The 'GPGGA' is set to 'OFF'. The 'GPRMC' is set to 'OFF'. The 'GPGST' is set to 'OFF'. The 'GPZDA' is set to 'OFF'. The 'GPVTG' is set to 'OFF'. The 'HCPPP Data' is set to 'OFF'. The 'Retransmit' is set to 'RTK' and 'OFF'. At the bottom, there are 'Confirm' and 'Back' buttons.

➤ Connection Protocol: NTRIP1.0

The screenshot shows the 'TCP/UDP Client' configuration window. The 'Connection Protocol' is set to 'NTRIP1.0'. The 'Server IP' is '192.168.3.18' and the 'Port' is '9900'. The 'Auto connect' checkbox is unchecked. The 'Password' field is filled with dots. The 'Mount Point' field is empty. The 'Differential Data' is set to 'OFF'. The 'Raw Data' is set to 'OFF'. The 'HRC Data' is set to 'OFF'. The 'GPSSA' is set to 'OFF'. The 'GPGGA' is set to 'OFF'. The 'GPRMC' is set to 'OFF'. The 'GPGST' is set to 'OFF'. The 'GPZDA' is set to 'OFF'. The 'GPVTG' is set to 'OFF'. The 'HCPPP Data' is set to 'OFF'. The 'Retransmit' is set to 'RTK' and 'OFF'. At the bottom, there are 'Confirm' and 'Back' buttons.

➤ Connection Protocol: NTRIP2.0

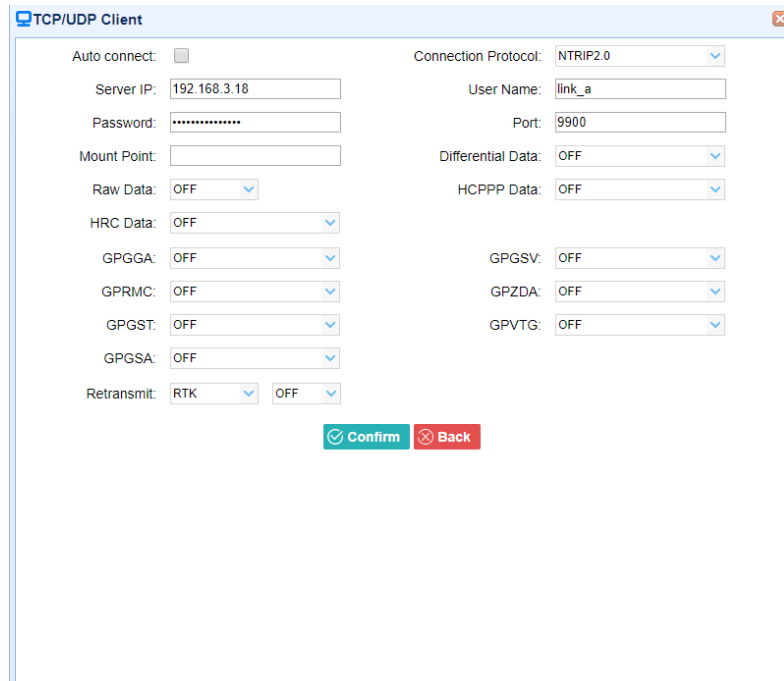

### 3. TCP Server/NTRIP Caster

Tap the **Connect** button to the right of required TCP Server/NTRIP Caster → the **IO Settings** screen will appear → select one of the connection protocols between NTRIP and TCP → configure the other related parameters → click **Confirm** to save the settings and open the server.

- Connection Protocol: TCP

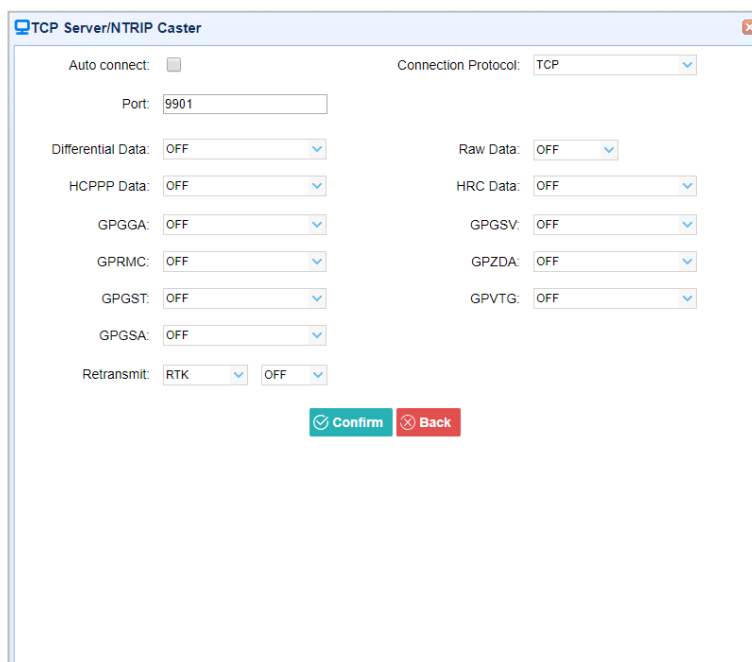

➤ Connection Protocol: NTRIP

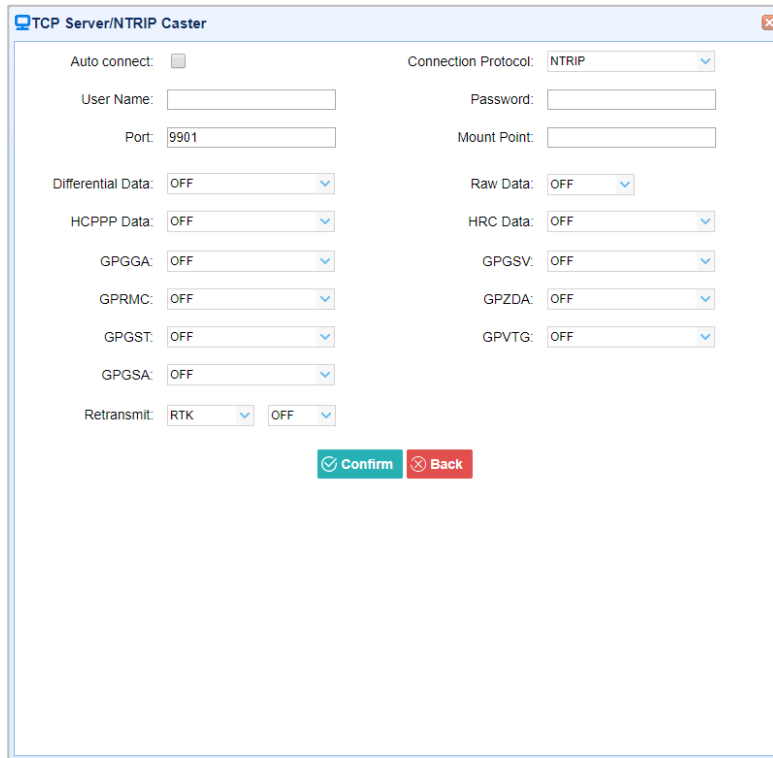

4. Serial Port

Tap the **Settings** button on the right of Serial Port → the *Serial Port Setup* screen will appear → select Baud Rate used to transmit data → configure the messages that you want to output through the serial port → click  **Confirm** to save the settings and start to transmit.

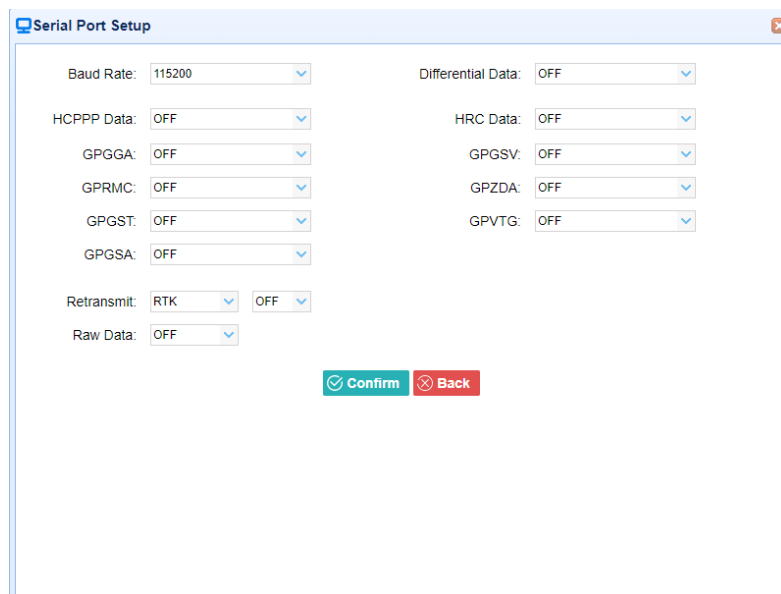

5. Bluetooth

Tap the **Settings** button to the right of Bluetooth → the *Bluetooth Set* screen will appear → configure the messages that you want to transmit through Bluetooth → click  to save the settings and start to transmit.

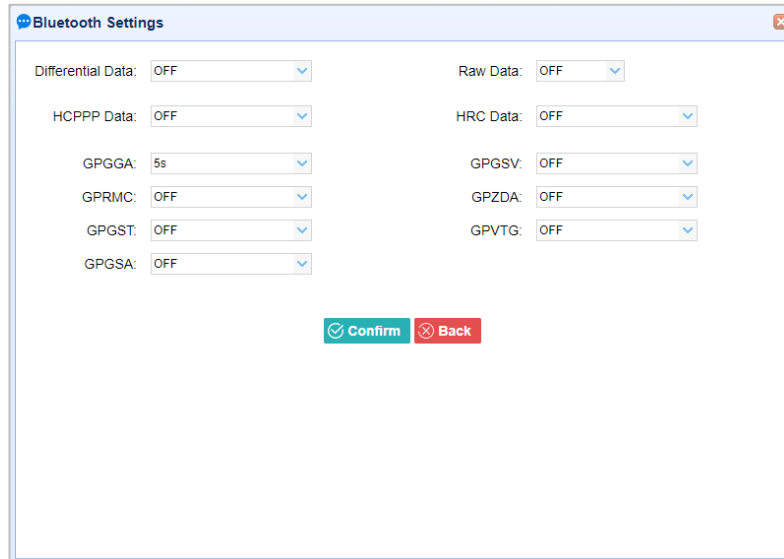

6. Radio

Tap the **Settings** button to the right of Radio → the *Radio Settings* screen will appear → select the format of differential data that you want to transmit through radio from the dropdown list → click  to save the settings and start to transmit.

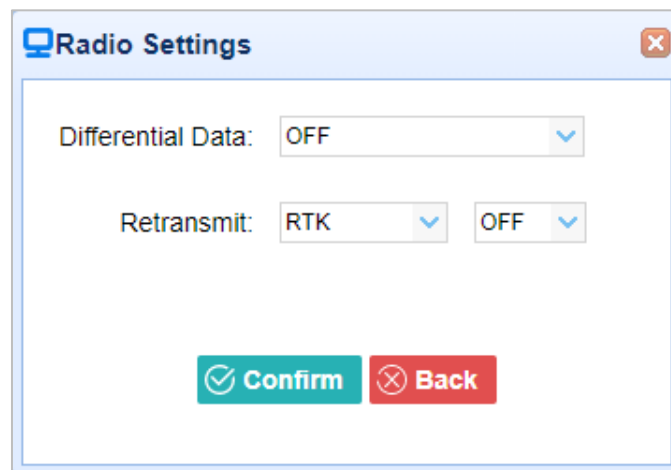

## 5.6 Network Setting Menu

Use this menu to view network information, configure the receiver’s mobile network, set email alert for specific situation, configure HTTP or HTTPS port, and the username and password of internal FTP site:

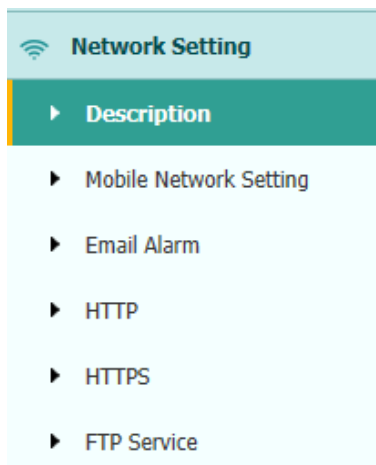

### 5.6.1 Description Submenu

Use this submenu to check the information of network setting.



### 5.6.2 Mobile Network Setting Submenu

Use this submenu to configure GPRS model, network module and modify dialing status.

The screenshot shows the 'Mobile Network Setting' window with a 'Network Settings' header. It contains several sections:

- GPRS Model Status:** Set to 'ON'. There are 'ON' and 'OFF' toggle buttons.
- Auto Start:** Radio buttons for 'Yes' and 'No'.
- Network Mode:** Radio buttons for '2G Only', '3G Only', '2G/3G Auto', '4G Only', and '2G/3G/4G Auto' (which is selected).
- SIM Type:** Set to 'E-SIM'. There is a 'Switch' button.
- Dialing Status:** Set to 'Offline'. There are 'Dial' and 'Break' buttons.
- Auto Connect:** Radio buttons for 'Yes' and 'No'.
- APN Details:**
  - APN: 3gnet
  - Dialing String: \*99#
  - User Name: card
  - Password: \*\*\*\*

A 'Save' button is located at the bottom of the settings area.

### 5.6.3 Email Alarm Submenu

Use this submenu to choose which situation of receiver will be alerted and input the email address.

Email Alarm ×

TO

Email Address 1:

Email Address 2:

Email Address 3:

Save

From

Account:

Password:

Server Address:

Save

Email Alert

- Receiver is powered on
- External power is off
- Battery level is low
- Ftp push is failed
- Reciever(license) will be expired in 7 days.

Save

### 5.6.4 HTTP Submenu

Use this submenu to configure HTTP port.

HTTP ×

HTTP Port:  Save

### 5.6.5 HTTPS Submenu

Use this submenu to configure HTTPS port.

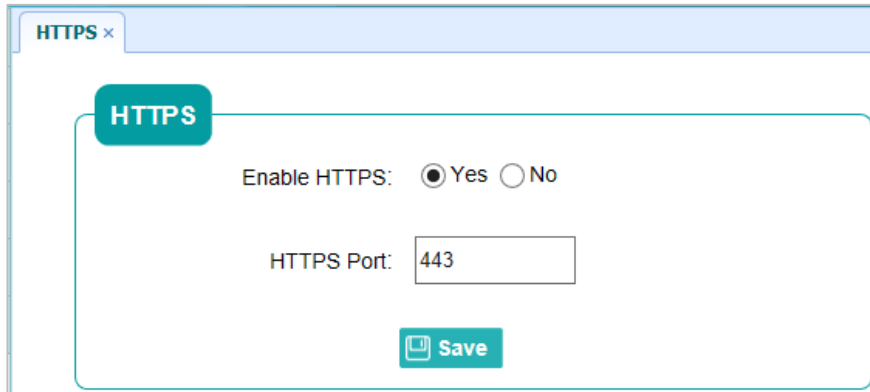

### 5.6.6 FTP Service Submenu

Use this submenu to configure the user name and password of internal FTP site.

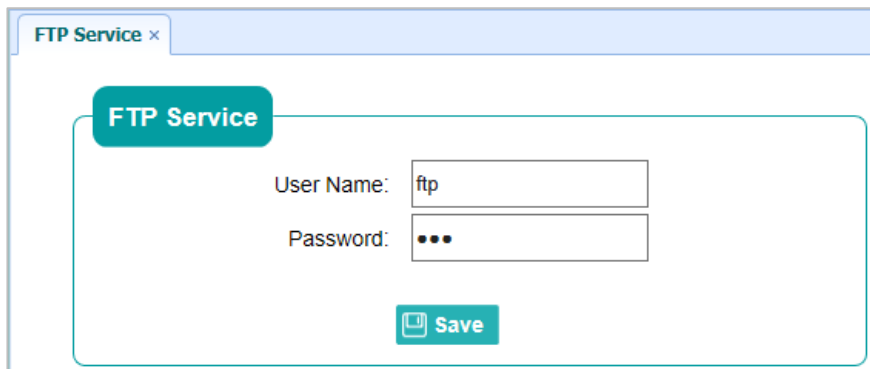

## 5.7 Module Setting Menu

Use this menu to check module information, configure WiFi, bluetooth, radio related settings, and turn on/off static voice of buzzer:

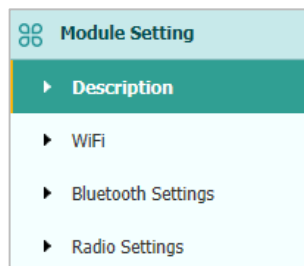

### 5.7.1 Description Submenu

Use this submenu to check the information of WiFi module, bluetooth module and radio module.

Description x

**Wi-Fi Information**

Power Status: ON

Wifi Mode: Access Point

MAC: 82:d2:10:04:ff:d2

Access Point Details

SSID: GNSS-3411955

**Radio Information**

Radio Type: Integrated TR Radio

Radio Power: 1W

OTA Baud Rate: 9600

Radio Frequency: 462.5500MHz

Radio Protocol: CHC

Radio Frequency Channel: Full Range

Frequency Range: 410MHz---470MHz

### 5.7.2 WiFi Submenu

Use this submenu to turn on/off WiFi function and modify password.

WiFi x

**WiFi**

Power Status: ON OFF

Auto Start:  Yes  No

SSID:

Start

### 5.7.3 Bluetooth Settings Submenu

Use this submenu to turn on/off bluetooth function and modify PIN number.

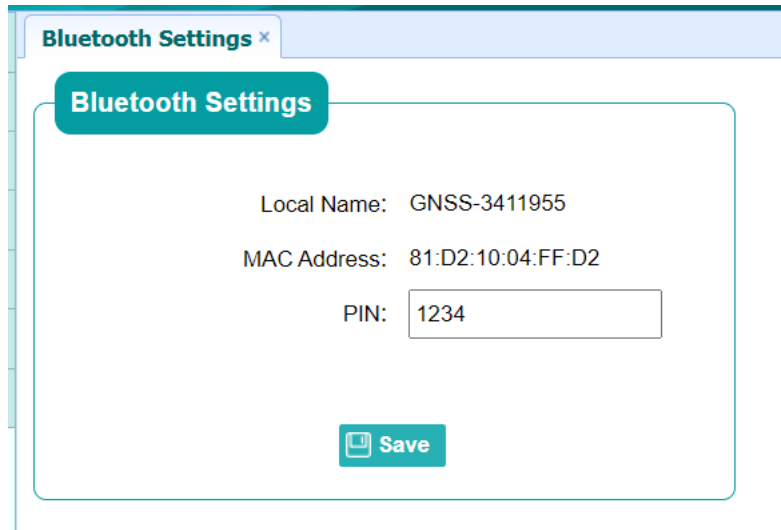

### 5.7.4 Radio Settings Submenu

Use this submenu to turn on/off radio function and configure radio parameters.

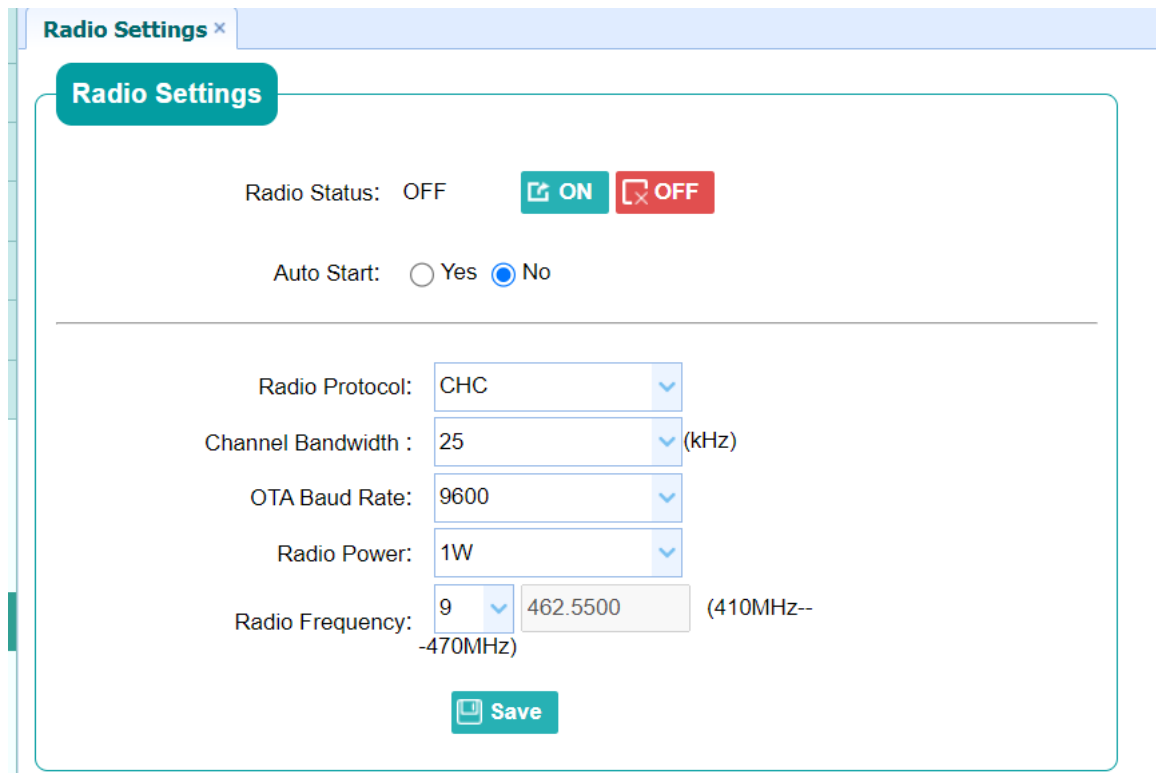

## 5.8 Firmware Menu

Use this menu to check the current firmware information, download the system log, update the receiver firmware, download or update the configuration file and register the receiver, and more:

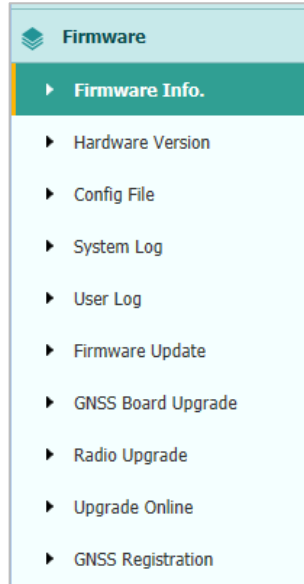

### 5.8.1 Firmware Info Submenu

Use this submenu to check the current firmware information. The following figure shows an example of the firmware information.

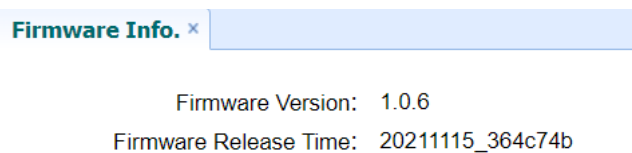

### 5.8.2 Hardware Version Submenu

Use this submenu to check the hardware information, including main board version and core board version:

Hardware Version x

Main Board: 1.0.1  
 Core Board: 1.0.1  
 PN: A19318430901060002  
 Board Firmware Version  
 Number: 21893

### 5.8.3 Config File Submenu

Use this submenu to update Configuration File.

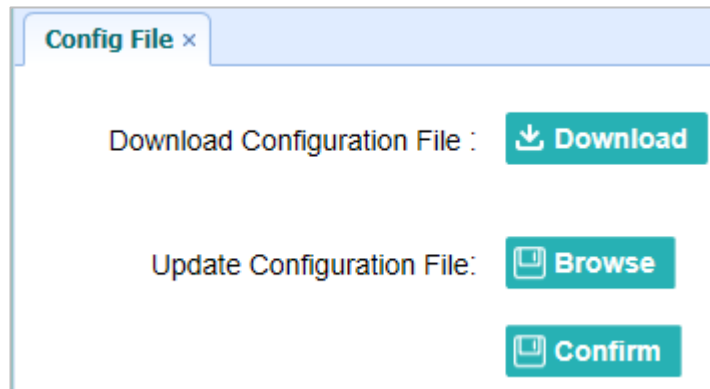

### 5.8.4 System Log Download Submenu

Use this submenu to download the system log of the receiver.

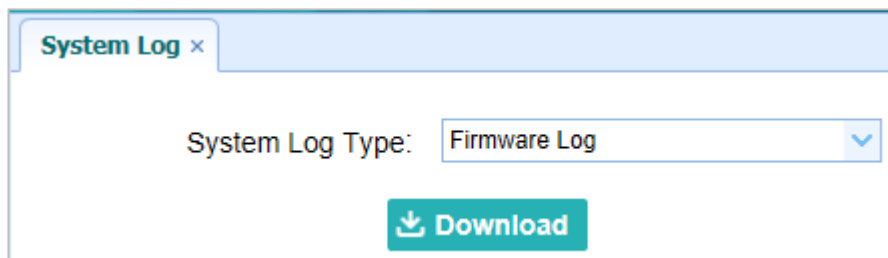

### 5.8.5 User Log Submenu

Use this submenu to download the user log. Tap **Download** to download current user log; Tick items that you want to see on the user log and tap confirm button to confirm selected user

log.

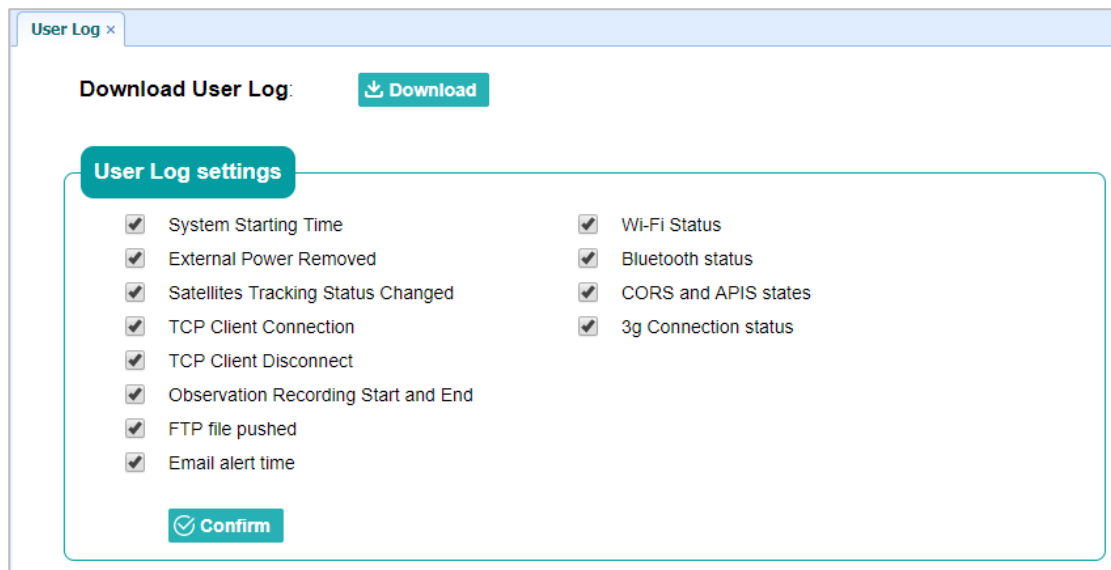

### 5.8.6 Firmware Update Submenu

Use this submenu to load new firmware to the receiver across the network. Tap the **Browse** button to locate the upgrade file → tap **Confirm** button to confirm the selected upgrading file and start upgrading.

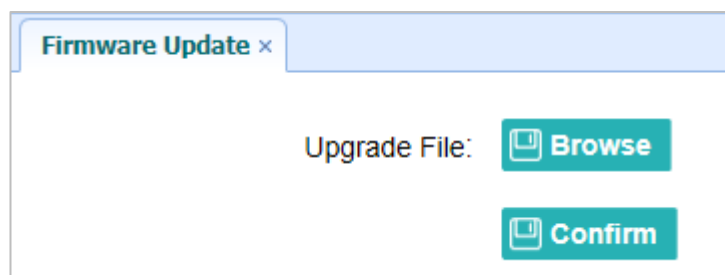

#### Notes

- It may take about 3 or 4 minutes to complete the firmware upgrading. Do not touch the power button or unplug the power until the upgrading process finishes, or damage will be caused to the receiver.
- The receiver will restart after the firmware upgrading is done, so users need to reconnect the receiver with your computer via Wi-Fi, and then log-in the receiver through a web browser to continue the configuration.

### 5.8.7 GNSS Board Upgrade Submenu

Use this submenu to upgrade GNSS Board. Use this submenu to load new board to the receiver across the network. Tap the **Browse** button to locate the upgrade file → tap **Confirm** button to confirm the selected upgrading file and start upgrading.

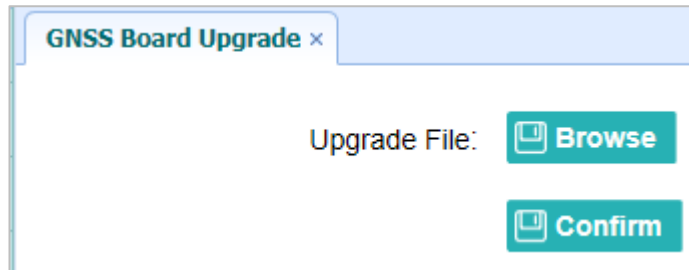

### 5.8.8 Radio Upgrade Submenu

Use this submenu to browse upgrade file and upgrade radio. Use this submenu to load new radio to the receiver across the network. Tap the **Browse** button to locate the upgrade file → tap **Confirm** button to confirm the selected upgrading file and start upgrading.

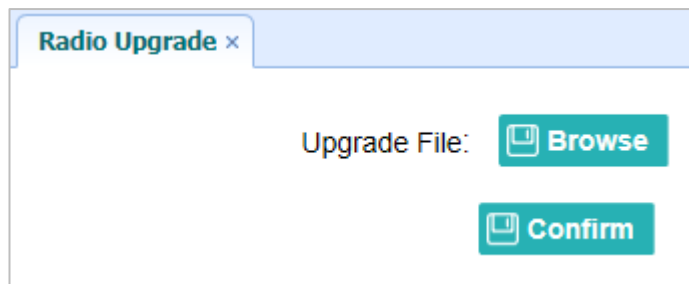

### 5.8.9 Upgrade Online Submenu

Use this submenu to input Server Address and upgrade online.

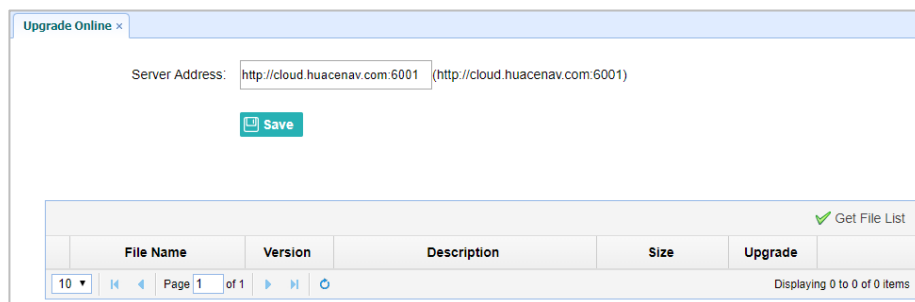

### 5.8.10 GNSS Registration Submenu

Use this submenu to register the receiver. Paste or enter the registration code to the *Registration Code* field → tap **Registration** button to complete the registration.

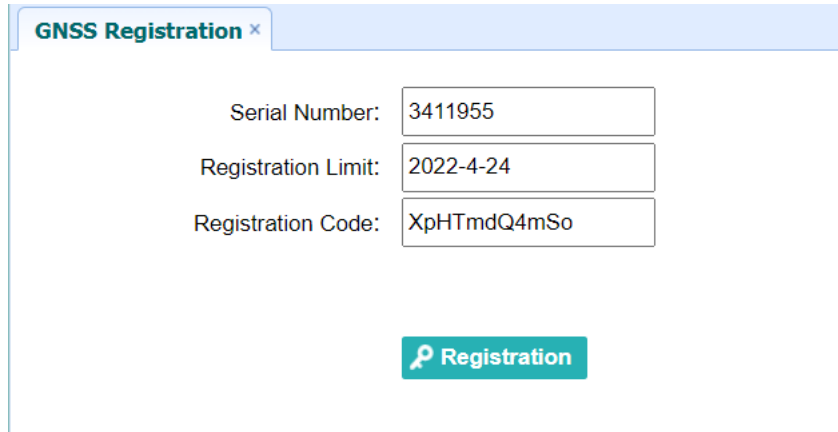

## 5.9 Cloud Service Setting Menu

### 5.9.1 Cloud Service Setting Submenu

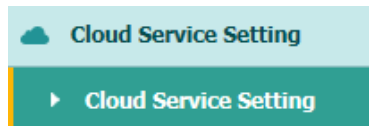

Use this submenu to turn on or turn off Cloud Service, Auto Start, Remote Control and configure other settings.

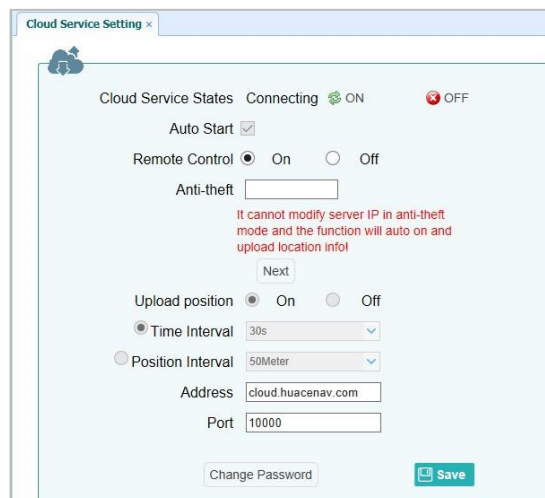

## A Communication Ports Definition

### AI CHC i83 Receiver IO Port (7-pin Lemo Port) Definition



PIN	FUNCTION
1	Ground ( - )
2	Ground ( - )
3	RS232-TX (Output)
4	PPS
5	Not Used
6	VIN
7	RS232-RX (Input)



## CHC Navigation

Shanghai Huace Navigation Technology Ltd.

CHCNAV | Smart Navigation & Geo-Spatial Technology Park,

577 Songying Road, 201703, Shanghai, China

Tel: +86 21 542 60 273 | Fax: +86 21 649 50 963

Email: [sales@chcnav.com](mailto:sales@chcnav.com) | [support@chcnav.com](mailto:support@chcnav.com)

Skype: chc\_support

Website: [www.chcnav.com](http://www.chcnav.com)

*This document is intended for general information purposes only. It does not consider the reader's specific circumstances and environmental constraints of use of GNSS.*

Make your work more efficient